

In the name of Allah the Beneficent and the Merciful



Hajj Guide for Pilgrims
With
Islamic Rulings (Ahkaam)
Philosophy &
Supplications (Duaas)

2006 Hajj Group
Shia-Muslim Association of Bay Area
San Jose, California, USA

First Edition (Revision 1.1)	December, 2003
Second Edition (Revision 2.1)	October, 2005
Third Edition (Revision 1.5)	November, 2006

Authors & Editors:

Hojjatul Islam Dr. Nabi Raza Abidi, Resident Scholar of Shia-Muslim Association of Bay Area
Hussnain Gardezi, Haider Ali, Urooj Kazmi, Akber Kazmi, Ali Hasan - Hajj-Guide Committee

Reviewers:

Hojjatul Islam Zaki Baqri, Hojjatul Islam Sayyed Mojtaba Beheshti, Batool Gardezi, Sayeed Himmati, Muzaffar Khan, and 2003 SABA Hajj Group

Hajj Committee:

Hojjatul Islam Dr. Nabi Raza Abidi, Dr. Mohammad Rakhshandehroo, Muzaffar Khan, Haider Ali, Ali Hasan, Sayeed Himmati

Copyright Free & Non-Profit Notice:

The SABA Hajj Guide can be freely copied, duplicated, reproduced, quoted, distributed, printed, used in derivative works and saved on any media and platform for non-profit and educational purposes only. A fee no higher than the cost of copying may be charged for the material.

Note from Hajj Committee:

The Publishers and the Authors have made every effort to present the Quranic verses, prophetic and masomeen traditions, their explanations, Islamic rulings from Manasik of Hajj books and the material from the sources referenced in an accurate, complete and clear manner. We ask for forgiveness from Allah (SWT) and the readers if any mistakes have been overlooked during the review process.

Contact Information:

Any correspondence related to this publication and all notations of errors or omissions should be addressed to Hajj Committee, Shia-Muslim Association of Bay Area at saba@saba-igc.org.

Published by:

Shia-Muslim Association of Bay Area
4415 Fortran Court, San Jose, California 95134, USA
Web: www.saba-igc.org
Email: saba@saba-igc.org

LIMIT OF LIABILITY/DISCLAIMER OF WARRANTY: THE PUBLISHER AND THE AUTHORS MAKE NO REPRESENTATIONS OR WARRANTIES WITH RESPECT TO THE ACCURACY OR COMPLETENESS OF THE CONTENTS OF THIS WORK AND SPECIFICALLY DISCLAIM ALL WARRANTIES, INCLUDING WITHOUT LIMITATION WARRANTIES OF FITNESS FOR A PARTICULAR PURPOSE. NO WARRANTY MAY BE CREATED OR EXTENDED BY SALES OR PROMOTIONAL MATERIALS. THE ADVICE AND STRATEGIES CONTAINED HEREIN MAY NOT BE SUITABLE FOR EVERY SITUATION. NEITHER THE PUBLISHER NOR THE AUTHORS SHALL BE LIABLE FOR DAMAGES ARISING HEREFROM. THE FACT THAT AN ORGANIZATION, BOOK OR WEBSITE IS REFERRED TO IN THIS WORK AS A CITATION AND/OR A POTENTIAL SOURCE OF FURTHER INFORMATION DOES NOT MEAN THAT THE AUTHORS OR THE PUBLISHER ENDORSES THE INFORMATION THE ORGANIZATION OR WEBSITE MAY PROVIDE OR RECOMMENDATIONS IT MAY MAKE. FURTHER, READERS SHOULD BE AWARE THAT BOOKS AND INTERNET WEBSITES LISTED IN THIS WORK MAY HAVE CHANGED OR DISAPPEARED BETWEEN WHEN THIS WORK WAS WRITTEN AND WHEN IT IS READ. SHIA ASSOCIATION OF BAY AREA IS NOT ASSOCIATED WITH ANY ORGANIZATION, PRODUCT OR VENDOR MENTIONED IN THIS BOOK.

This book is dedicated for the sawab of all the deceased momaneen and momanaat. Please recite a surah Fatiah and three times surah Tawheed for the souls of all our brother and sisters who are not with us and remember them in your prayers.

Table of Contents

Table of Contents	4
Chapter 1. Travel Information for Pilgrims	7
1.1. Hajj Preparations and Requirements	7
1.1.1. Passport.....	7
1.1.2. Visa.....	7
1.1.3. Required Documents for Hajj Visa.....	7
1.1.4. Embassy Contact Information for Visa.....	7
1.1.5. General Health and Vaccination	8
1.1.6. Medications	8
1.1.6.1. Prescription Medications.....	8
1.1.6.2. Prescription Eye Glasses.....	8
1.1.7. First Aid Kit.....	8
1.1.8. Travel and Health Insurance	9
1.1.9. Luggage	9
1.2. List of Items for Hajj	9
1.2.1. Required Items.....	9
1.2.2. Optional Items	9
1.3. Money for Personal Use and Shopping	10
1.4. Spiritual Training	10
1.4.1. Recommended Readings.....	10
1.4.2. Optional Books to Carry for Hajj	10
1.5. Physical Training.....	10
1.6. Travel Process - Instructions on How to Proceed for Hajj	11
1.6.1. Before Departing	11
1.6.2. Departing from the Home Airport	11
1.6.3. Transit.....	11
1.6.4. On the Plane.....	11
1.6.5. Arriving at Jeddah.....	11
1.6.6. Jeddah to Medina.....	11
1.7. Accomodations and Hotel Etiquettes at Mecca and Medina	11
1.8. Food and Drink.....	12
1.9. Visiting the Holy Mosques of Mecca and Medina	12
1.9.1. Information and DON'Ts in Holy Kaaba Mosque in Mecca:.....	12
1.9.2. Visiting the Holy Prophet's (p) Mosque in Medina:.....	13
1.10. Shopping Hints.....	13
Chapter 2. Pilgrimage Sites in Medina	14
2.1. Ziyara'ats in Medina.....	16
2.1.1. Masjid-e-Nabawee.....	16
2.1.1.1. Bab-e-Jibra'el.....	17
2.1.1.2. Maqam-e-Jibra'el.....	17
2.1.1.3. Riyadul Jannah.....	18
2.1.1.4. Mimeter-e-Rasul	18
2.1.1.5. Mehrab-e-Nabawee.....	18
2.1.1.6. Pillar of Hannana	18
2.1.1.7. Pillar of Tawba.....	18
2.1.1.8. Pillar of Mahras.....	18
2.1.1.9. Pillar of Wufood	18
2.1.1.10. House of Imam Ali (a) and Bibi Fatimah al-Zahra (a).....	18
2.1.1.11. Stage of Suffa.....	19
2.1.1.12. House of Imam Hassan (a).....	19
2.1.2. Jannatul Baquee.....	19
2.1.2.1. Bibi Fatemah al-Zahra (a)	19
2.1.2.2. Imam Hassan (a) 2 nd Imam	19
2.1.2.3. Imam Zainul Abadeen (a) 4 th Imam.....	20
2.1.2.4. Imam Muhammad Baqir (a) 5 th Imam	20

2.1.2.5. Imam Jaffer Sadiq (a) 6 th Imam	20
2.1.2.6. Bibi Fatemah Binte Asad	20
2.1.2.7. Bibi Ummul Baneen	20
2.1.2.8. Bibi Halimah	20
2.1.2.9. Bibi Safiya and Bibi Atika	20
2.1.2.10. Bibi Ruqayya, Umm-e-Kulthum and Zaynab	20
2.1.2.11. Bibi Juwara, Saudah, Ayishah, Hafsa, Umme Habibah (a), Umme Salma (a), Safiyyah and Zainab	20
2.1.2.12. Abbas Ibne Abdul-mutalib	20
2.1.2.13. Ibrahim ibne Muhammad (a)	20
2.1.2.14. Ismail ibne Jaffer	20
2.1.3. Ziya'art In and Around Medina	21
2.1.3.1. House of Abu Ayyub Ansari	21
2.1.3.2. Masjid-e-Shams (Masjid of Sun)	21
2.1.3.3. Masjid-e-Zul-Qiblatayn (Masjid of two Qiblahs)	21
2.1.3.4. Masjid-e-Quba	21
2.1.3.5. The Sab-Saba Masajid	21
2.1.3.6. Masjid-e-Fatah	21
2.1.3.7. Masjid-e-Salman-e-Farsee (a)	21
2.1.3.8. Masjid-e-Ali (a)	22
2.1.3.9. Masjid-e-Bibi Fatimah Zehra (a)	22
2.1.3.10. Hazrat Hamza (a) - Ohud	22
2.2. Maps of Janaat-ul-Baqi	24
Chapter 3. Duaas and Ziyara'at for Medina	27
Chapter 4. Pilgrimage Sites in Mecca	54
4.1. Maps of Holy Kaaba and Mecca Mosque	54
4.2. Ziyara'ats in and around Mecca	58
4.2.1. Kaaba	58
4.2.2. Hajr-e-Ismail	59
4.2.3. Hajr-ul-Aswad	60
4.2.4. Makaam-e-Ibrahim	60
4.2.5. Zam Zam	61
4.2.6. Hills of Safa and Marwa	62
4.2.7. Jannat al-Mualla	62
4.2.7.1. Bibi Khadijatul Kubra (a)	62
4.2.7.2. Abu Talib bin Abdul Mutalib (a)	63
4.2.7.3. Abdul Mutalib (a)	63
4.2.7.4. Hazrat Abdullah bin Abdul Mutalib (a)	63
4.2.7.5. Hazrat Amina Bint-e-Wahab	63
4.2.8. Masjid-e-Jinn	64
4.2.9. Cave of Thawr	64
4.2.10. Cave of Hira	65
4.2.11. Arafah	66
4.2.12. Jabal-e-Rahmah	66
4.2.13. Muzdhalifa or Ma'shar	67
4.2.14. Mina	67
4.2.15. Masjid-e-Kheef in Mina	67
4.3. Approximate Distances to Mina, Muzdalifah and Arafat	67
4.4. Maps of Mecca and Surroundings	68
Chapter 5. Islamic Legal Rulings (Ahka'am) for Umra-e-Tamatto and Hajj-e-Tamatto	74
5.1. Taqlid Requirements	74
5.2. Khums	74
5.3. Proper Qira'at	74
5.4. Types of Hajj	75
5.4.1. Hajj-e-Tamatto	75
5.4.2. Hajj-e-Ifraad	75
5.4.3. Hajj-e-Qiran	75
5.5. Hajj-e-Tamatto	77
5.5.1. Umra-e-Tamatto	77

5.5.1.1. Meeqaat.....	77
5.5.1.2. Ihram.....	79
5.5.1.3. Talbia.....	80
5.5.1.4. Haraam Acts after Wearing Ihram.....	80
5.5.1.5. Tawaf-e-Kaaba.....	81
5.5.1.6. Obligations to be Fulfilled before Tawaf.....	82
5.5.1.7. Obligations to be Fulfilled during Tawaf.....	82
5.5.1.8. Salat-e-Tawaf.....	83
5.5.1.9. Sa'ee.....	83
5.5.1.10. Taqseer.....	84
5.5.1.11. Four Things Remain Hara'am after Taqseer of Umra-e-Tamatto.....	84
5.5.2. Hajj-e-Tamatto.....	85
5.5.2.1. Wear Ihram for Hajj-e-Tamatto on 8 th Dul Al-Hijja.....	85
5.5.2.2. Haraam Acts after Wearing Ihram.....	85
5.5.2.3. Talbia.....	86
5.5.2.4. Stay in Arafat on 9 th Dul Al-Hijja.....	86
5.5.2.5. Stay in Muzdalfa'a on the 10 th of Dul Al-Hijja.....	87
5.5.2.6. Rami the Big Shaita'an, Al-Aqaba, on 10 th of Dul Al-Hijja between Sunrise and Sunset.....	87
5.5.2.7. Sacrificing an Animal on 10 th Dul Al-Hijja after Rami at Big Shaita'an.....	90
5.5.2.8. Halq or Taqseer.....	90
5.5.2.9. Stay in Mina for the Night of 11 th and 12 th Dul Al-Hijja.....	91
5.5.2.10. Rami all Three Shaita'an on 11 th and 12 th of Dul Al-Hijja.....	91
5.5.2.11. Tawaf-e-Kaaba for Haj-e-Tamatto.....	92
5.5.2.12. Obligations to be Fulfilled before Tawaf.....	92
5.5.2.13. Obligations to be Fulfilled during Tawaf.....	92
5.5.2.14. Salat-e-Tawaf.....	93
5.5.2.15. Sa'ee.....	93
5.5.2.16. Tawaf-un-Nisa.....	94
5.5.2.17. Salat-e-Tawaf-un-Nisa.....	94
5.5.3. Umra-e-Mufradah (Optional Umra).....	94
Chapter 6. Brief Philosophy and Background of Hajj.....	95
6.1. The First Stage.....	96
6.2. The Second Stage.....	97
6.2.1. First Action:.....	97
6.2.2. Second Action:.....	98
6.2.3. Third Action:.....	98
6.2.4. Fourth Action:.....	99
6.2.5. Fifth Action:.....	99
6.2.6. Sixth Action:.....	100
6.2.7. Seventh Action:.....	100
6.2.8. Eighth Action:.....	101
6.2.9. Ninth Action:.....	101
6.2.10. Tenth Action:.....	102
6.2.11. Eleventh Action:.....	103
6.2.12. Twelfth Action:.....	104
6.2.13. Thirteenth Action:.....	104
6.3. The Third Stage:.....	106
Acknowledgements.....	108
Appendix A: Reference Hajj books for additional reading.....	109
Appendix B: Useful English to Arabic Words and Phrases.....	110
Appendix C: Glossary of Words Used in Religious Texts.....	115

Chapter 1. Travel Information for Pilgrims

1.1. Hajj Preparations and Requirements

1.1.1. Passport

Pilgrims are required to have a valid passport for a minimum of six months from the date of visit.

1.1.2. Visa

The group leader will obtain, or help pilgrims obtain a visa from proper authorities before the trip. Pilgrims are responsible to get visas of other countries they want to visit after Hajj.

1.1.3. Required Documents for Hajj Visa

It is the responsibility of every pilgrim to provide the following documents for obtaining the Hajj visa from the Saudi Government.

- Valid Passport for a 6 month period from the date of travel for each person traveling
- Meningitis vaccination certificate
- Marriage certificate copy (If you are married and traveling together for Hajj)
- Birth certificate copy of the children traveling with you
- If you have a uncommon Islamic name on your passport then you should have a letter from the local Islamic center certifying that you are a Muslim otherwise you will be refused entry to Mecca or Medina
- Round trip air ticket
- Bank drafts, cashier checks or International money orders to cover the required entry fees and trip expenses.
- For ladies, not traveling with a Mahrum, a Mahrum certificate completed and signed by an Islamic Center.

NOTE: All pilgrims (Hujjaj) are advised to carry with them a couple of photocopies of their passport which shows their personal information. American green cards holders, should make sure to carry their own green card in their wallets all the time. They should also carry a photo copy of their green card separately in a safe place.

1.1.4. Embassy Contact Information for Visa

- The Kingdom of Saudi Arabia for Hajj & Umra Visa
The Consular Section, 866 United Nations Plaza, Room # 480, New York, NY 10017,
Telephone # (212) 752- 2740.
- The Kingdom of Saudi Arabia for Hajj & Umra Visa
The Consular Section, 601 Newhamshire Avenue North W., Washington DC 20037
Telephone # (202) 342- 3800
- The Kingdom of Saudi Arabia for Hajj & Umra Visa
The Consular Section, 5718 Westheimer, Suite # 1500, Houston, TX 77057
Telephone # (713) 785- 5577
- The Kingdom of Saudi Arabia for Hajj & Umra Visa
The Consular Section, 10900 Wilshire Blvd., Suite # 830, Los Angeles, CA 90024
Telephone # (310) 208- 6566

- The Kingdom of Saudi Arabia for Hajj & Umra Visa
The Consular Section, 99 Bank Street, Suite # 260, Ottawa, Ont. K1P 6B9
Telephone # (613) 237- 4100 Fax # (613) 237- 0567

1.1.5. General Health and Vaccination

Complete Medical and Dental checkup and clearance from your Doctor is recommended before you embark on the pilgrimage

Required Vaccinations:

- Meningococcal Meningitis
- Yellow Fever, for pilgrims arriving from countries know to have it according to World Health Organization (WHO)

Recommended Vaccinations:

- Hepatitis A and B
- Flu Shots
- Diphtheria-Tetanus-Polio
- Yellow Fever

1.1.6. Medications

On a separate small card please mention all the conditions you are suffering from and taking medications for, along with your Blood Group. This card should remain with you all the time along with the ID card that will be issued to you by the Hajj group.

1.1.6.1. Prescription Medications

- Please carry two sets of prescription medicines that you use regularly, one set in your carryon bag and the other set in checked baggage.
- **FOR LADIES ONLY:**
 - It is recommended to consult your personal family doctor couple of months in advance to get a prescription for stopping menstruation (periods) during the hajj trip. You **CANNOT PERFORM HAJJ DURING MENSTRUATION, CANNOT ENTER ANY MASJID OR JANAT-UL BAQEE**. Check Hajj group leader for any Duas or Ziyarats that you may recite from outside the Holy Haram.
 - HIJAB: Women must wear Hijab at all times and avoid make- up during the trip especially in Medina and Mecca.

1.1.6.2. Prescription Eye Glasses

- Keep an extra pair of prescription eye glasses.
- Straps for eye glasses are recommended so they don't fall and break.

1.1.7. First Aid Kit

- Headache medicine (Tylenol, Aspirin, Paracetamol)
- Cough/Cold/Flu/Throat (cough drops or syrup) medication
- Small Ice Pack
- Allergy medication
- Alcohol cleaning pads
- Anti-biotic cream (Neosporin), gauze, band-aids, first aid pressure tape and adhesive tape.
- Diarrhea, constipation and acidity/heartburn medication
- Ointment for eye infection and sterile eye drops for cleaning and lubrication
- Thermometer

1.1.8. Travel and Health Insurance

Every pilgrim is responsible to purchase their own medical, accident and travel (which includes travel cancellation and loss of luggage) insurance. Names of the insurance agencies can be provided to Hujjaj upon request.

1.1.9. Luggage

- One hiking backpack (*weighing less than 18 lbs.*) with rollers and shoulder straps to be carried on the plane and while walking during hajj rites).
- One 30 inches hard top bag with rollers for check-in (*weighing less than 65 pounds*)
- Pack an extra pair of clothes in the carryon bag in case your unacompanied bag is lost

1.2. List of Items for Hajj

1.2.1. Required Items

- Light weight sleeping bag
- Air and/or Travel Pillow
- Prayer Matt with a built-in "STRAW Sijdah-gaah"
- Small pouch to collect pebbles for stoning Shayateen (RAMY JAMARAAT)
- A small bag with handles or straps to carry your shoes and some items with you while visiting the Holy Haram.
- Pocket size supplication book
- Open top sandals with well cushioned rubberized sole and unstitched straps on top.
- One extra pair of comfortable walking shoes for daily use
- Scissors and a nail clipper
- Toiletries and personal hygiene items e.g. tooth brush
- Unscented soap, shampoo, tooth paste, shaving soap and moisturizing cream which are non oil based
- A card mentioning the conditions you are suffering from and taking medications for along with your Blood Group.
- **FOR MEN**
 - A hair or beard trimming machine to remove long hair before shaving the head
 - Shaving blades and their holder for shaving the head
- **FOR LADIES ONLY**
 - For Hajj and Umra
 - 3 White light cotton loose pants and shirts (e.g. Shalwar Kurta).
 - 2 white pairs of knee highs.
 - 1 pair of white comfortable non-leather walking shoes. Bring one extra shoe. It could be purchased in Mecca or Medina.
 - White cotton undergarments.
 - IHRAM – Scarf and Chador will be provided by the group
 - For Normal Use:
 - 2 daily wear cotton out fits.
 - 1 Abaya and scarf.
 - **HIJAB:** Women must wear Hijab at all times and avoid make- up during the trip especially in Medina and Mecca.

1.2.2. Optional Items

- Neck pouch (non-leather) for carrying currency, personal items, writing pen, personal will and identification papers
- Mini travel alarm clock
- Cotton undergarments

- Sun block lotion, however, while in wudhoo or Ihraam you must not wear any lotion or cream that blocks water from reaching your skin
- Hat, cap, or a small traveling umbrella
- Spray bottle with or without battery operated fan (to stay cool in hot scorching sun)
- Flash light with extra batteries.
- Personal communication devices (walkie talkies) to stay in touch with your group while visiting haram.
- You can bring GSM phone and purchase phone cards (chip) which are widely available
- Travel compass for Qibla and general directions.
- 220/110 Volts converter with an American to European plug adapter
- Please make your own arrangements if the pilgrim requires any special assistance e.g.
 - Walking cane, wheel chair if required
 - Knee, shoulder, elbow and ankle braces if required
 - There are no American toilets at some places especially at Arafat, Muzdalifa and Mina. Please make your own arrangements for portable toilet chair that converts eastern style toilet to western style commode if needed
 - Light weight collapsible travel chair
 - "Other" specific items as prescribed by your doctor

1.3. Money for Personal Use and Shopping

- Carry 500 dollars (*cash*) in large (\$100) bills which are easier to convert to Riyals
- American express or Visa traveler's checks should be used if one wants to carry more than \$500.
- Credit cards can also be used throughout Mecca, Medina and Jeddah

1.4. Spiritual Training

1.4.1. Recommended Readings

1. **Hajj – The Islamic Pilgrimage** by Syed Mohammad Zia Abidi
Available on-line at: <http://www.al-islam.org/thehajj/>
2. **Secrets of the Hajj** by Ayatullah al Hajj ash Shaykh Husain Mazaheri
Available on-line at: <http://www.al-islam.org/secretsofthehajj/>
3. **Hajj** authored by Dr. Ali Shariati
Available on-line at: <http://www.al-islam.org/hajj/shariati/>
4. **Lantern of the Path** by Fadlullah Haeri translation of the original Arabic text titled "Misbah al-shariyah wa Miftah al-Haqiqah".
Available on-line at: <http://www.rafed.net/books/other-lang/mesbah/>

1.4.2. Optional Books to Carry for Hajj

- Mafateeh-ul-Janaan pocket edition
- Hajj Ahkaam book from your Marjah
- Pocket edition of Arabic-English dictionary
- Adabul Haramain (English), Ansariyan Publications

1.5. Physical Training

- A pilgrim should walk 4 to 5 miles every alternate day from atleast a month prior to the pilgrimage, to be physically fit for the pilgrimage.
- During Hajj, on some days, one would be walking up to 7 miles or more. Just Sa'ai, comprising 7 rounds between Safa and Marwa, is three and half miles long.

1.6. Travel Process - Instructions on How to Proceed for Hajj

1.6.1. Before Departing

Before departing pilgrims should check that they have all the required items (mentioned above) in their luggage specially their travel documents and medicines.

1.6.2. Departing from the Home Airport

In USA due to the increased security pilgrims should arrive at least 4 hours before the flight time so the group can assemble at a place and any additional instructions can be given to them.

1.6.3. Transit

All the pilgrims are requested to be together and obey the instructions of the group leader at all times during the flight transit.

1.6.4. On the Plane

It is recommended to

- Walk and stretch while on the plane.
- Drink plenty of water to avoid dehydration.
- Some planes have designated places for praying, if not, then you may pray while sitting in your seat. Ulema say that it does not matter which direction you are facing in this case.

1.6.5. Arriving at Jeddah

Once the group arrives in Jeddah they will be taken to the arrival hall where they will fill out an arrival card and wait for their papers to be processed. That may take anywhere from 1 to 6 hours. After clearing customs and immigration you will collect your baggage and proceed to Hajj passport control. The passports will be deposited with the Hajj authorities at the passport control. The group and their baggage, will then proceed to its designated place at Jeddah Hajj terminal for onward flight to Medina.

1.6.6. Jeddah to Medina

The keywords are **COMPROMISE, RELAX** and **FOLLOW the LEADER**. When traveling by plane to Medina, seats for all Medina flights are released on first come first serve basis due to heavy crowds. A group may have to wait for several hours before boarding a flight to Medina. Tickets for the trip from Jeddah to Medina will be purchased by your group leader from the Saudi Airlines office at the Hajj terminal. Normally if you fly by Saudi Airlines from New York, you arrive in Jeddah at about 4: 30 PM and it takes anywhere from 6 to 8 hours to clear Immigration and customs. Therefore be mentally prepared for spending that night at the Hajj terminal as your flight to Medina may be early next morning. The group may also travel to Medina by bus if flights are not available.

1.7. Accommodations and Hotel Etiquettes at Mecca and Medina

It is strongly suggested that a Hajj group finds accommodation near the Holy Mosques in Mecca and Medina. Taxi fares tend to go up drastically as Hajj dates get closer. It is also very convenient for everyone especially the older people in the group to travel to the Holy Mosques and not be dependent on the transportation.

- Whenever you leave your hotel to visit the Holy Haram, or go out for any other reason, **always inform the group leader of your plans**. This ensures that if you get lost the group would know where to look for you.
- If you are the last person, in your group, to leave the hotel always lock your room and deposit the keys at the front desk.
- Always keep your ID card and, at least, 100 Riyals with you all the time.
- Do not keep valuables and cash in your suitcase. Safety boxes are usually available at the hotel for extra money. Ask your group leader if you need one
- Be advised that many restaurants have men only or family only sections

1.8. Food and Drink

Following advice is from the Saudi Ministry of Hajj

“Drink bottled mineral water. Tap water and water from any other source, with the exception of Zamzam water, should not be used for drinking purposes. Drink plenty of water which will prevent you from becoming dehydrated.

Water used for drinking, brushing teeth or making ice should be boiled first or otherwise sterilized. Milk should be boiled, unless it is pasteurized. Powdered or tinned milk is available and is recommended, but make sure it is reconstituted with pure water. Soft drinks of all kinds are available in Saudi Arabia at all shopping establishments and are safe to drink.

Only eat well-cooked meat and fish, preferably served hot. Vegetables should be cooked and fruit peeled.”

1.9. Visiting the Holy Mosques of Mecca and Medina

- You should perform two Rakaat Salaat with the niyat of Tahiaat-e-Masjid (as a mark of respect for the Mosque) whenever you enter any of the Holy Mosques in Mecca, Medina and surrounding areas.
- Full Salaat, instead of Qasar, is recommended in the cities of Mecca and Medina as these two cities are supposed to be home for all Muslims.
- HIJAB: Women must wear Hijab at all times and avoid make- up during the trip especially in Medina and Mecca.
- A’ADAB: It is recommended to perform Ghusl (Mustahab) and be in Wudhu all the time when going to the Holy Haram.

1.9.1. Information and DON’Ts in Holy Kaaba Mosque in Mecca:

- An information office is situated inside the Holy Haram in Mecca near Mount Safa. The office also provides licensed wheel chairs and Tawaf carriers at reasonable rates. Their rates are much cheaper than those of private carriers.
- **Do NOT** pause, sit, stand, or obstruct people who are circumambulating (tawaaf) the Kaaba as you or others may fall and get trampled. Keep walking, while in crowd, and slowly make your way out.
- **Do NOT** perform any Salaat in the circle, where people are circumambulating near the Kaaba, to avoid obstructing the safe passage of people.
- **Do NOT** cut in or out of the main flow of people performing circumambulation (tawaaf) against the general direction.
- **Do NOT** touch the wall of Kaaba while circumambulating (tawaaf).
- To start your circumambulation (tawaaf) of the Kaaba join the people in the outer edge of the circle and slowly make your way in.
- Women **CAN NOT** perform Hajj during menstruation. You must consult your doctor before leaving for Hajj for any medication.

- A'ADAB: It is strictly recommended to perform Ghusl (Mustahab) and be in Wudhu all the time when going to the Holy Haram.
- HIJAB: Women must wear Hijab at all times and avoid make-up.

1.9.2. Visiting the Holy Prophet's (p) Mosque in Medina:

- There are separate timings for women to visit the Holy shrines of the Holy Prophet (p), except daily prayers, and Jaanat-ul-Baqi cemetery. Please confirm these hours with your group leader before visiting.
- The Mosque is closed right after isha prayers. Check with your leader about the timing schedule.
- Women **MUST NOT** enter the Holy Mosque and other Holy places while menstruating. Check with your group leader about details. Also you must consult your doctor before leaving for Hajj for any medication to delay the menstruation.
- A'ADAB: It is recommended to perform Ghusl (Mustahab) and be in Wudhu all the time when going to the Holy Haram.
- HIJAB: Women must wear Hijab at all times and avoid make-up.
- Every morning at about 3:30 AM you can go to the Holy Haram for Salaat-e-Shab also called Salaat-e-Lail (night prayers). The night prayers are highly recommended especially if you are staying near the Holy Haram. Two Adhaans are recited in the morning and one Ekamat for the Fajr Salaat. If you wish to pray inside the Holy Haram then you should take your own straw mat to do your prostration on it. There are many small areas and walkways in the Holy Haram where there are no carpets and can be used to prostrate on the ground. After the morning Salaat men proceed to Janat-ul-Baquee. Around 7:00 am, the authorities allow ladies to do the Ziyarat of the Holy Prophet's Zaree, by opening the partition doors from the hall inside Ba'ab-e-Ali (a) gate. Ladies are advised to be inside the hall of Ba'ab-e-Ali (a) gate as early as possible. Only two hours a day are allowed for ladies to do the ziyarat. Due to the heavy crowds, God forbid, you may not get a chance to enter the main Mosque if you are late! After Ziyarat you should try and return to your Hotel for breakfast and rest during the day. If you wish to go for Salaat at the Masjid during Dhohar and Asr, you may do so. The Holy Haram closes after Isha Salaat.
- Hujjaj who are required to pray '**kasar**' under normal circumstances, are recommended to pray full Salaat in Mecca and Medina if staying in a Hotel near the Holy Haram.
- Two Rakaat Salaat with the **Niyat of Tahiyat-e-Masjid** is highly recommended whenever you enter the Holy Prophet's (p) Mosque.

1.10. Shopping Hints

There are a vast variety of shops closer to the Holy Harams in Mecca and Medina. The shops carry all sorts of items that you may want to buy for gifts like; Tasbeeh, Prayer Rug (Ja-e-Salat), Jewelry, Watches, Clothes, etc.

Note: Gold items are cheaper in Medina than Mecca! It is highly recommended that you bargain while shopping.

- There is a vast variety of duty free shopping at Dubai airport.
- There is Hala'al Burger King and KFC in Mecca outside of King Abdul Aziz Gate on the South Eastern side of Holy Haram.

Chapter 2. Pilgrimage Sites in Medina

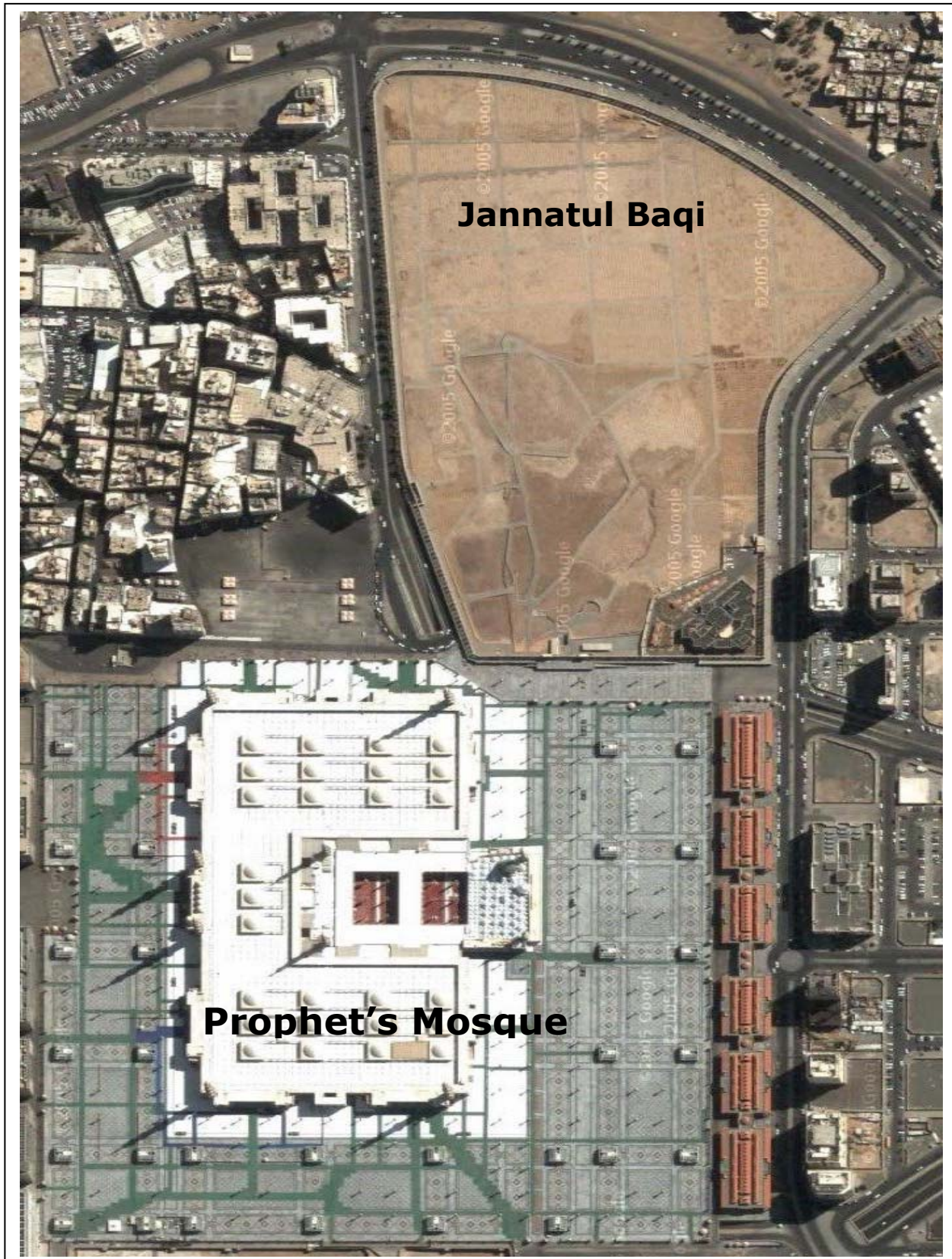

Satellite Photograph of Prophet's Mosque and Jannatul Baqi in Medina

Map of the Holy Mosque in Medina (Historical extension are also shown)

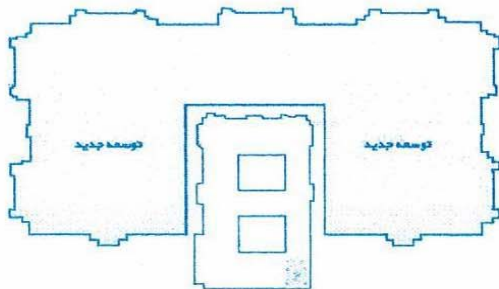
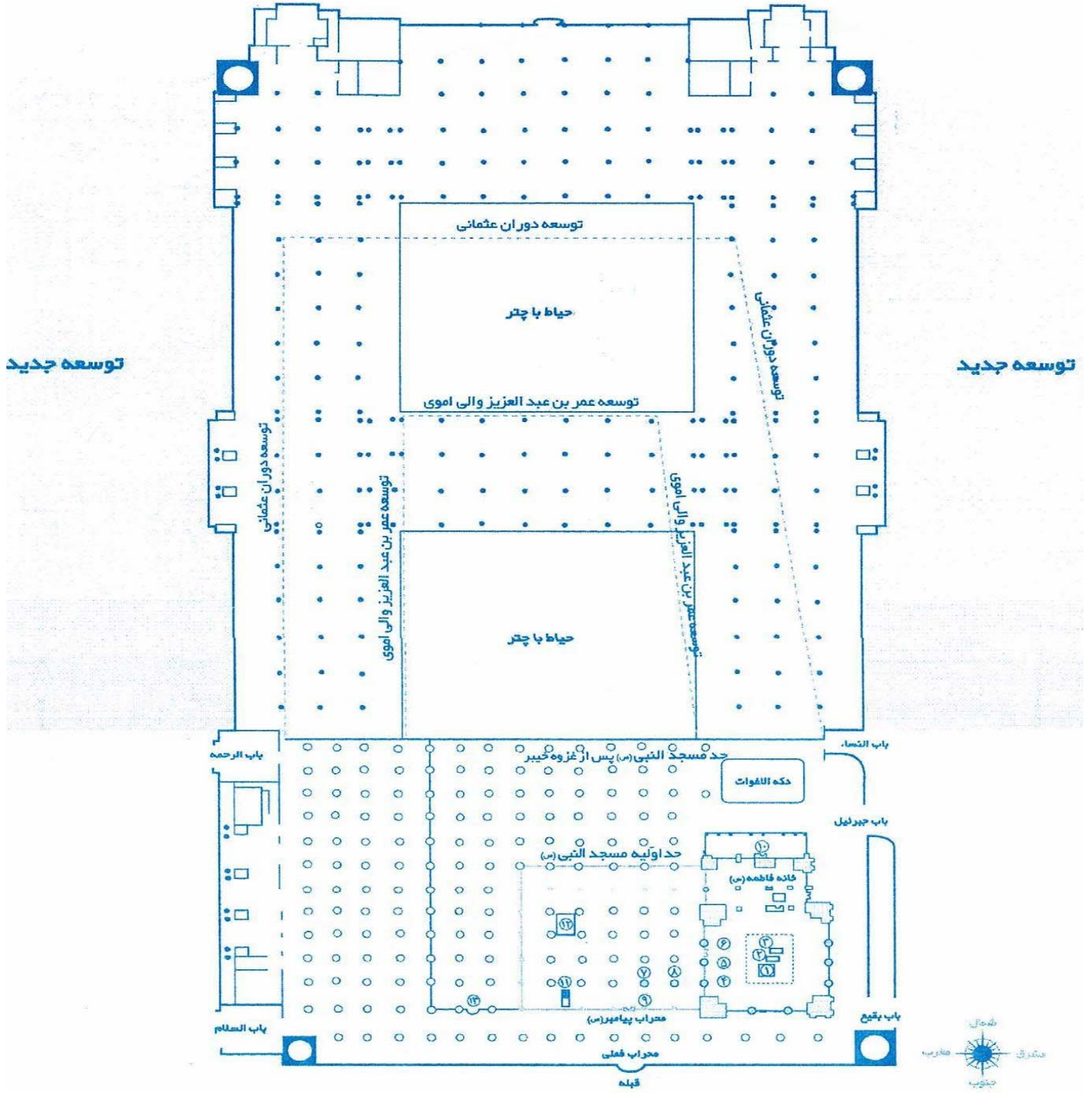

- | | |
|------------------------|-------------------|
| ① مرقد مطهر پیامبر (س) | ⑨ ستون مخلقه |
| ② قبر خلیفه اول | ⑩ محراب توحید |
| ③ قبر خلیفه دوم | ⑪ منبر پیامبر (س) |
| ④ ستون سریر | ⑫ محل اذان بلال |
| ⑤ ستون محرس | ⑬ محراب سلیمانی |
| ⑥ ستون وفود | |
| ⑦ ستون قرعه (عایشه) | |
| ⑧ ستون توبه (ابولبابه) | |

2.1. Ziyara'ats in Medina

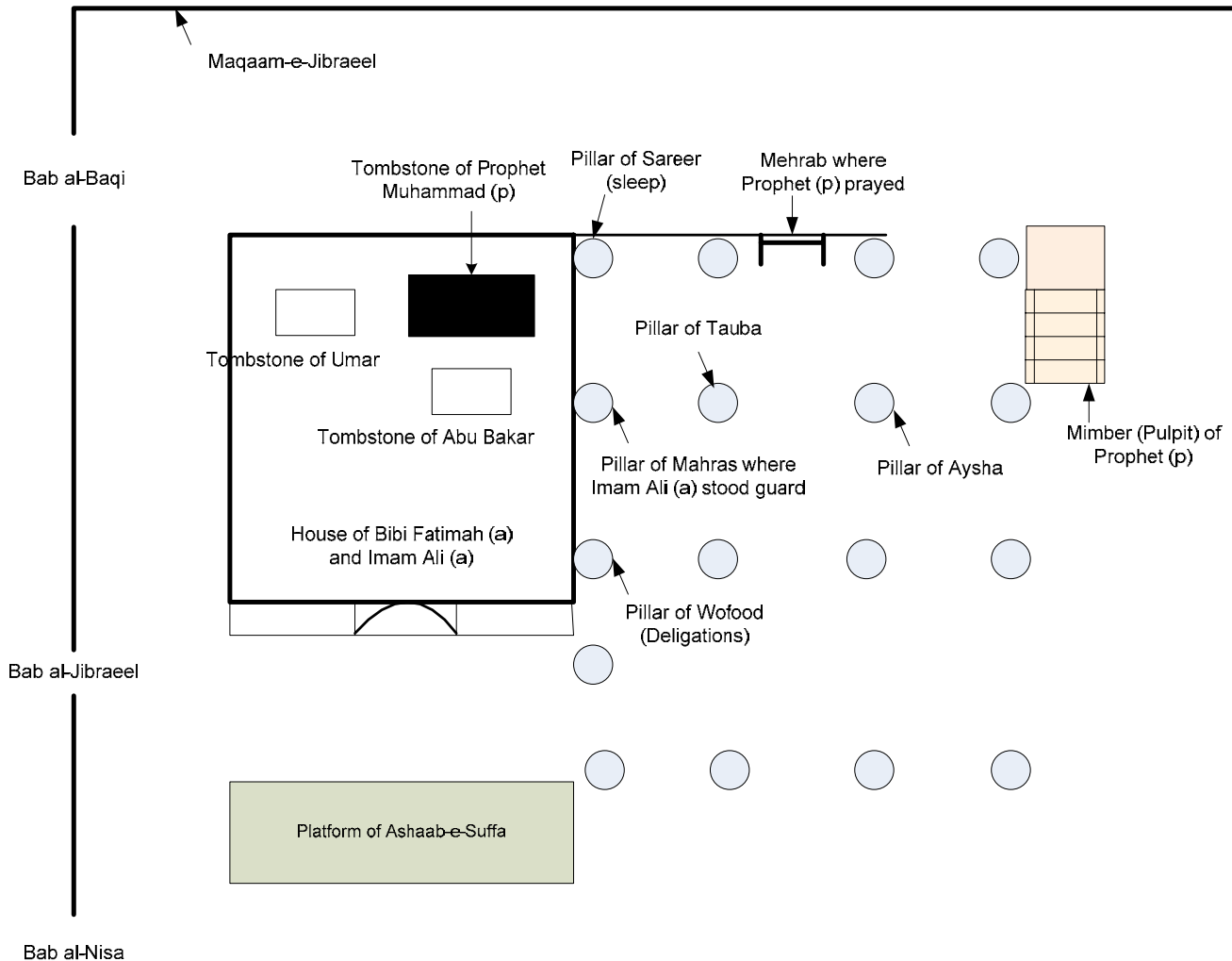

"A piece of Jannat is between my Minbar and grave" - Prophet Muhammad (p)

Prophet Muhammad's (p) Mosque in Medina

2.1.1. Masjid-e-Nabawee

This mosque is in Medina that can hold up to 2 million people. The Prophet Muhammad Mustafa (a) laid the foundations and built the mosque after his migration to Medina. He used to live in a chamber adjacent to the mosque along with his only child Bibi Fatima a-Zahra (a). The Prophet (p) is also buried in that Masjid-e-Nabawee under the green dome. A small section of the mosque, with the green dome was re-built by Turks on the original foundations of the mosque. If you follow the sketch of the Masjid-e-Nabawee you will notice that there are many pillars and places of importance, which will be explained later briefly.

Prophet Muhammad (a) was born in Mecca on 17th Rabi-ul-Awwal 3rd year of Elephant. His father had passed away before he was born. His mother, Amina Binte Wahab, also passed away when he was five years old. The Prophet's (a) grandfather Abdul-Muttalib (a) became his guardian and raised him. When he was eight years old his beloved grandfather also passed away.

Then his beloved paternal uncle Hazrat Abu Talib (a) took him into his guardianship. He and his wife Bib Fatimah binte Asad (a) raised the Prophet (p) like his real father and mother in such a way that Prophet (p) never realized that he was an orphan and a lone child. The faithful uncle always kept the Prophet (p) with him during day or night and stood watch on him when he slept. Hazrat Abu Talib (a) always protected the Prophet (p) from pagan Arabs who were out to kill him for being the last Prophet of Islam that eradicated the pagan religion.

At the age of 25 he married Bibi Khadija Kubra'a (a). When he was 40 years old, the revelation came to him from Allah (SWT) ordering him to 'recite in the name of Allah' and spread the word of Islam to Arabs. The first to know about the call towards Allah's (SWT) from the Prophet was Bibi Khadija Kubra'a (a) and his cousin Imam Ali (a) while they were with him in Cave of Hira.

During his last pilgrimage to Mecca, at Ghadeer-e-Khum, the Holy Prophet of Islam, as per Allah's (SWT) command, proclaimed that Imam Ali (a), would be his successor, in accordance to the wishes of the Almighty Allah (SWT). The Prophet of Islam passed away on the 28th Safar 11th year A.H.



Mehrab and Mimbar of Prophet Muhammad [p] inside Masjid-e-Nabawee

2.1.1.1. Bab-e-Jibra'el

This is the door through which Hazrat-e-Jibra'el (a) used to enter the chamber of Janabe Fatemah Zehra (a).

2.1.1.2. Maqam-e-Jibra'el

Hazrat-e-Jibra'el (a) always used to come to the Prophet of Islam with a Wahee 'revelation' through that door.

2.1.1.3. Riyadul Jannah

It is narrated from Prophet Muhammad (p) that a piece of Jannat is between his Mamber (pulpit) and his Zaree (the burial place). Some historians say that Bibi Fatema (a) is buried there. It is also said that the Prophet (p) of Islam was heard saying that this piece of land would be raised to meet Jannat on the Day of Judgment.

2.1.1.4. Mamber-e-Rasul

Situated to the West of Prophet's (a) Zaree is the Mimbar-e-Rasul (an elevated stage). This is the same mamber that the Holy Prophet (p) used to give speeches (khutbas) from.

2.1.1.5. Mehrab-e-Nabawee

In between the Prophet's (a) Zaree and the Mimbar-e-Rasul is the Mehrab-e-Nabawee. It is from this Mehrab that the Prophet of Islam used to lead Salaat-e-Jamaat.

2.1.1.6. Pillar of Hannana

Adjoining Mehrab-e-Nabawee is the pillar of Hannaana. The Prophet (p) of Allah (SWT) used to lean against a date palm tree, that used to be at that spot, to give Khutba. After the Mamber was built, however, the Prophet (p) used the mamber for giving khutba. The date palm tree complained and cried. The Prophet of Islam reassured the date palm tree that it would accompany the Prophet in Jannat. The pillar of Hannana was erected where the tree used to stand.

2.1.1.7. Pillar of Tawba

The pillar, just North-West of Kabre Mubarak of Prophet (p) and, between the Kabre Mubarak and the Mehra'ab of Rasul is the Pillar of Tawba. It is narrated that Abu Labbaaba spied on the Prophet of Islam to leak the command of Allah (SWT) about the death sentence for Jews in Medina who connived against Islam to kill all Muslims during the battle of the Trench (Khanda'ak). Abu Labbaba then repented for this mistake he came to Masjid-e-Nabawee, tied himself to a date tree, and cried desperately for forgiveness.

One day when the Prophet (p) of Allah (SWT) was resting in the hujra of Umme Salma (a), Hazrat-e-Jibra'el (a) came with the ayah of the Quran which mentions the forgiveness of Abu Labbaaba. The Prophet (p) untied Abu Labbaaba and gave him the good news that Allah (SWT) had forgiven him. A Pillar was erected at the same location and it is recommended that one should pray two Rakaat Salaat and ask for forgiveness near that pillar.

2.1.1.8. Pillar of Mahras

This pillar stands where Imam Ali (a) used to stand guard over the Prophet (p) of Allah (SWT) when he slept at night.

2.1.1.9. Pillar of Wufood

Whenever people from outside Medina came to visit the Prophet (p), he would receive their delegation at the place of that pillar.

2.1.1.10. House of Imam Ali (a) and Bibi Fatimah al-Zahra (a)

The house of Bibi Fatimah al-Zahra (a) and Imam Ali (a) is located besides the house of Prophet Muhammad (p) where he is buried.

Prophet ordered that all the doors of the houses opening toward the mosque be closed except the door of Ali (a) and Fatimah (a). This shows that Ali (a), Fatimah (a), and their descendants were entirely free from impurity, as is clearly illustrated by the 'verse of purity' in the Holy Qur'an 33:33.

2.1.1.11. Stage of Suffa

This is the stage just North of Prophet's (p) burial place inside the mosque. The new converts to Islam (newly Muslims) who were poor and could not afford a place of their own for boarding and lodging used to stay under a shelter built by the Prophet (p) at a place where that stage is located today. Those new Muslims used to come to Medina from different parts of the world. They were housed and fed by the Prophet (p) till they found their own shelter.

2.1.1.12. House of Imam Hassan (a)

The house of Imam Hassan (a) was situated just South of the grave of Prophet Muhammad (p). It is to your left when entering the Holy Mosque through Bab-e-Jibra'el towards the Qibla. Nowadays, it is the silver dome building that is a library known as 'Maktab-e-Sheikh-Arif Hikmat'

2.1.2. Jannatul Baquee

This is a public cemetery in existence since the days of the Prophet (p) of Islam. Many Masumeen, Ashab, Momineen and Shohada-e-Ohad are buried there. Some of prominent graves are of the following members of the Ahlul Bayt.



Masjid-e-Nabawee with Baquee cemetery in the background

2.1.2.1. Bibi Fatemah al-Zahra (a)

The only daughter of Holy Prophet Muhammad (p), according to some historians, is buried here. Other traditions indicate that she is buried in her house inside Masjid-e-Nabawee.

2.1.2.2. Imam Hassan (a) 2nd Imam

This beloved grand son of Prophet (p) was not allowed by Aisha to be buried next to the Prophet (p) in Masjid-e-Nabawee, per his will.

2.1.2.3. Imam Zainul Abadeen (a) 4th Imam

Elder son of Imam Hussain (a)

2.1.2.4. Imam Muhammad Baqir (a) 5th Imam

Son of Imam Zainul Abadeen (a)

2.1.2.5. Imam Jaffer Sadiq (a) 6th Imam

Son of Imam Muhammad Baqir (a)

2.1.2.6. Bibi Fatemah Binte Asad

Wife of Abu Talib (a) bin Abdul Mutallib and Mother of Imam Ali (a) 1st Imam

2.1.2.7. Bibi Ummul Baneen

Wife of Imam Ali (a) and mother of Hazrat Abbas (a)

2.1.2.8. Bibi Halimah

Wet nurse of Holy Prophet Muhammad (p).

2.1.2.9. Bibi Safiya and Bibi Atika

Paternal aunts of the Prophet (p) of Allah (SWT).

2.1.2.10. Bibi Ruqayya, Umm-e-Kulthum and Zaynab

The adopted daughters of Prophet Muhammad (p).

2.1.2.11. Bibi Juwara, Saudah, Ayishah, Hafsa, Umme Habibah (a), Umme Salma (a), Safiyyah and Zainab

The wives of the Prophet (p) of Allah (SWT).

2.1.2.12. Abbas Ibne Abdul-mutalib

One of the uncles of the Prophet (p).

2.1.2.13. Ibrahim ibne Muhammad (a)

Son of the Prophet Muhammad (p) and brother of Bibi Fatema Zehra (a).

2.1.2.14. Ismail ibne Jaffer

Son of Imam Jaffer Sadiq (a), 6th Imam.



Masjid-e-Nabawee on the left and Baqee cemetery on the right

2.1.3. Ziya'art In and Around Medina

The following Ziyara'ats are located in and around the city of Medina.

2.1.3.1. House of Abu Ayyub Ansari

There is a famous hadith that when the Prophet (p) of Allah (SWT) first arrived in Medina several Ansars wanted to host him. It was difficult for the Prophet (p) to decide who to choose, as his host, so he announced that he would stay wherever his camel stops.

The camel stopped in front of the House of Abu Ayyub Ansari. This is the first house in Medina where the Prophet (p) stayed. Unfortunately the house has been demolished and 'Court of Justice' has been built at the site.

2.1.3.2. Masjid-e-Shams (Masjid of Sun)

It is narrated that the Prophet (p) fell asleep in the lap of Imam Ali (a) before Dhohar till the Maghrib. Imam Ali (a) said his Dhohar and Asar Salaat sitting down.

Just before Maghrib, the Prophet (p) woke up and pointed his finger at the setting sun which came up and the Prophet (p) prayed his Dhohar and Asr Salaat. In Iraq there is another Masjid called **MASJID-RADUS-SHAMS** which got its name when Imam Ali (a) did the same action to return the setting sun.

2.1.3.3. Masjid-e-Zul-Qiblatayn (Masjid of two Qiblahs)

One day when Prophet (p) of Allah (SWT) was leading Salaat-e-Dhohar a revelation came to him after the second Rakaat to change his direction of Salaat from Bait-ul-Muqaddas to the Kaaba.

Islam's previous Qibla was Bait-ul-Muqaddas. Before the change in the direction the Jews used to taunt the Holy Prophet (p) that his followers did not have their own direction for Salaat.

2.1.3.4. Masjid-e-Quba

This was the first Masjid that the Prophet (p) of Allah (SWT) built upon his arrival from Mecca. It is narrated that the Prophet (p) of Allah (SWT) was heard saying that if you say two Rakaats Salaat in this Masjid you will get the Thawab of one Umra.

2.1.3.5. The Sab-Saba Masajid

This was the place where the battle of Khandaq was fought. About five Masajid were erected to commemorate that event. The battle got the name Khandaq (trench) that was dug as per the advice of Salman-e-Farsee (a) for the defence of Muslims, who were very few in numbers, as opposed to the great army of non believer pagan Arabs, Jews, and their allies. This battle strategy was common in Iran, the native country of Hazrat Salaman-e-Farsee's (a).

2.1.3.6. Masjid-e-Fatah

This Masjid is situated on the hilltop at Khandaq . It is narrated that the Prophet of Islam stayed in a tent at this place for three days praying for the success of the Muslims.

2.1.3.7. Masjid-e-Salman-e-Farsee (a)

This Masjid is situated near Masjid-e-Fatah. It is said that the tent of Salaman-e-Farsee was erected at this masjid.

2.1.3.8. Masjid-e-Ali (a)

This Masjid, where Imam Ali (a) stayed, is on the hill opposite to Masjid-e-Fatah.

2.1.3.9. Masjid-e-Bibi Fatimah Zehra (a)

This Masjid was used by Bibi Fatimah Zehra (a) and is located before Masjid-e-Ali (a). Unfortunately this Masjid is now closed.

2.1.3.10. Hazrat Hamza (a) - Ohud

The lion of Allah, Hazrat Hamza (a), uncle of the Prophet (p) of Islam is buried alongwith many Shohada of Ohud in the battlefield of Ohud.

It is narrated from Prophet Muhammad (p) that whoever comes to his Ziyarat and does not go to the Ziyarat of his uncle Hamza (a) has been unfaithful to the Prophet (p). Ohud is the place where the second Islamic war with the pagans and Mushrikeen (non-believers), lead by Abu Sufya'an (M), took place.

At the beginning of this war the Muslims were winning. However, a group of archers stationed on a mountain, behind the Muslim army, to block the ememy from attacking from the rear, left their position to go and loot the belongings of the retreating soldiers of unbelievers, despite strict instructions from the Prophet (p) to not leave their position.

As soon as the non-believers came to know that the archers, from the Muslim army, had left, they re-grouped and attacked the Muslims from the rear. All Muslims, except a few, fled the battle leaving the Prophet (p), Imam Ali (a) and a few others behind to fight the non-believers valiantly and fend off their attacks on the Prophet (p). It is narrated that Hazrat Jibra'el (a) brought the sword Zulfiqar from heaven for Imam Ali (a) at this time.

During your stay in Medina, you should spend as much time as possible at Masjid-e-Nabawee and Jannat-ul-Baquee.



Graves of Hazrat Hamza (a), uncle of the Prophet (p) and other Shuhada-e-Ohud



Jabal (Mount) Ohud as seen from Masjid-e-Nabawee

2.2. Maps of Janaat-ul-Baqi

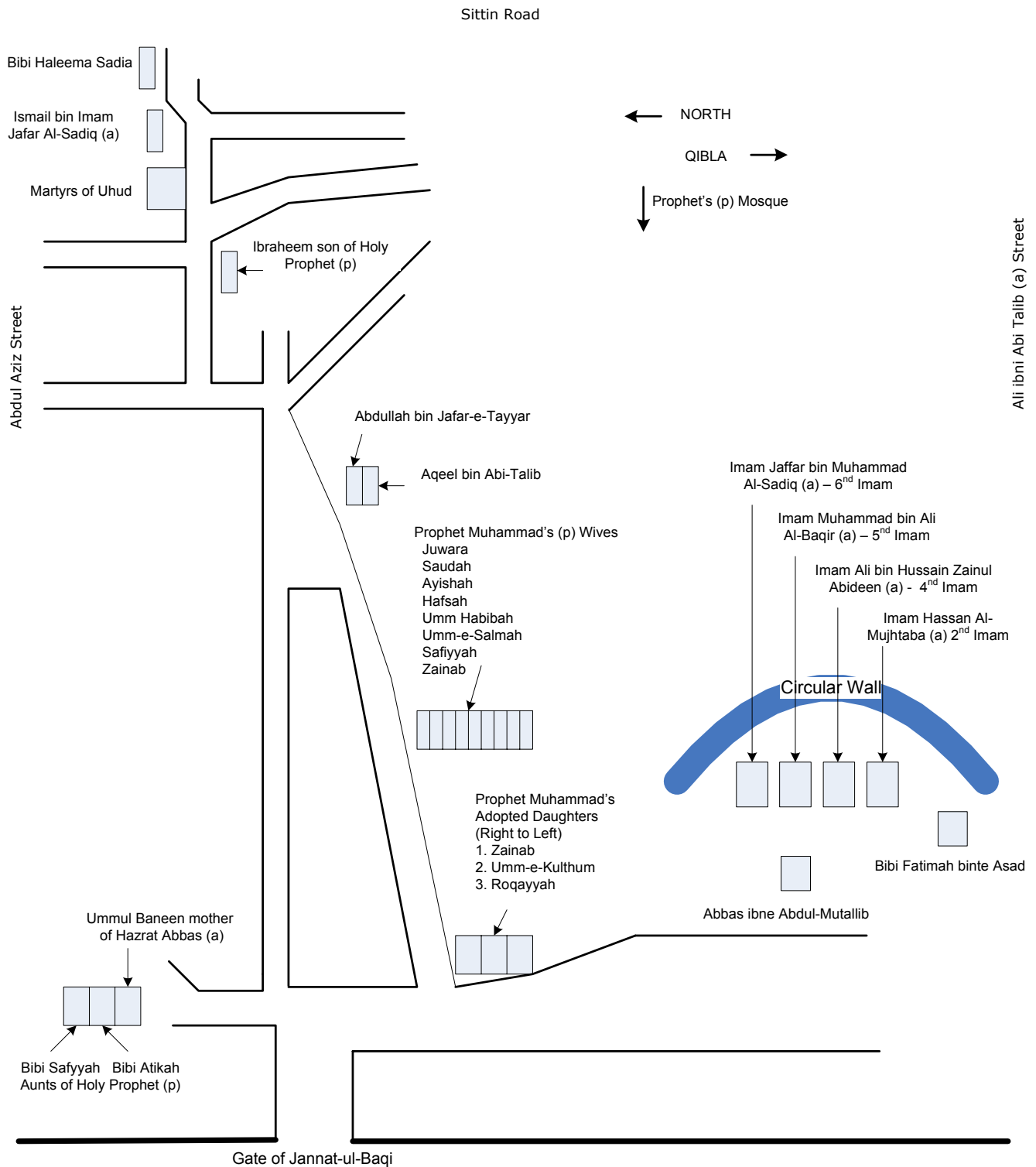

Map of the graveyard of Baqi "Jannat-ul-Baqi" in Medina
(The sketch is not drawn to scale)



Graveyard of Janaat-ul-Baqi, Medina

قبرستان یقوع

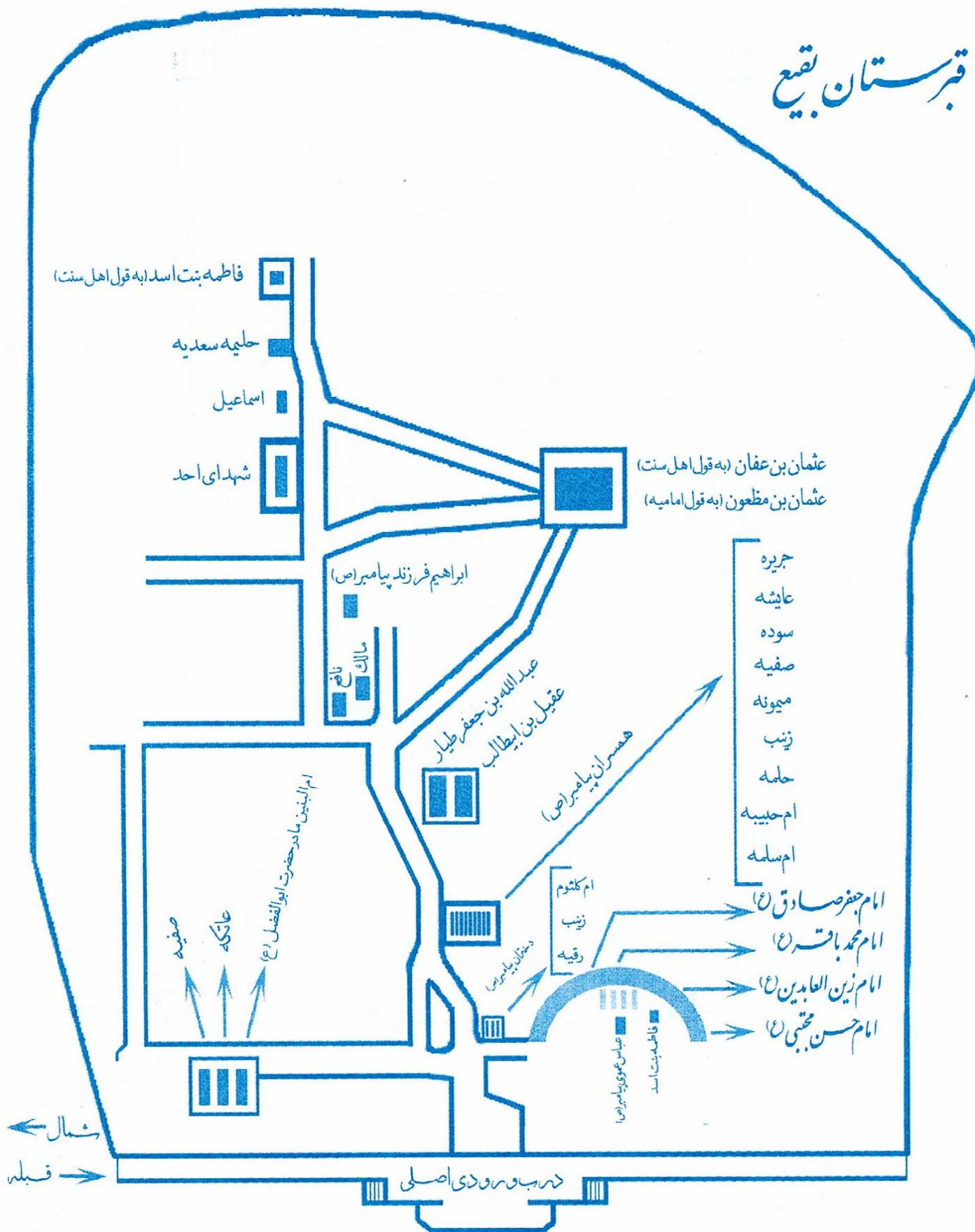

Chapter 3. Duaas and Ziyara'at for Medina

MADINATUL MUNAWWARA

(The lighted city)

MADINATUN NABI

(The city of the Prophet)

"My son! If someone visits me whilst I am alive or dead, or visits your father, your brother or yourself, it becomes WAJIB on me to visit him/her on the day of Qiyama and rescue him/her from his/her sins."

Prophet (S.A.W.) to Imam Husayn (A.S.)

APPROACHING MADINA

As soon as you see the city, remember that it is the city of the Prophet (S.A.W.) You will be walking upon the very places where the Prophet (S.A.W.) walked. Remember, that although you cannot visualise him in the physical world, it is he to whom you sent salaams to in every salaa, raise your hopes in anticipation of meeting him.....

(Please note that many areas of Masjidun Nabi are partitioned off for the ladies)

ENTERING THE MASJID

Bab e Jibrail is the best door to enter from - it is located on the north west side of the masjid.

Ask permission to enter :

أَدْخُلْ يَا رَسُولَ اللَّهِ

أَدْخُلْ يَا فَاطِمَةَ

May I enter O Messenger of Allah?

May I enter O Fatima?

As you cross the threshold, enter with humility reciting:

بِسْمِ اللَّهِ وَبِاللَّهِ وَعَلَىٰ سُنَّةِ رَسُولِ اللَّهِ

Recite takbeer 100x as you walk in.

Walking through the door you will see a structure ahead and to the left. It is the 'zarih' The nearest end is the house of Bibi Fatima (A.S.) whilst further to the left are the graves of the Prophet (S.A.W.), Abu Bakr and Umar.

Greet the Prophet (S.A.W.) whilst standing as near as possible, standing in his presence as though he were still alive in the physical world. He knows you are there, and that you have come to visit

In Prophet's Mosque

The Ziyarat of Medina

Idhn al-Dukhul - permission to enter the Prophet's mosque for the ziyarat of the Prophet:

اللَّهُمَّ اِنِّى وَقَفْتُ عَلَى بَابِ بَيْتِ بْنِ يُوْنُسَ نَبِيِّكَ وَاللَّيْلِ
نَبِيِّكَ عَلَيْهِ وَعَلَيْهِمُ السَّلَامُ وَقَدْ مَنَعْتِ النَّاسَ الدُّخُوْلَ اِلَى
بُيُوْتِهِ الْاِبَاذِيْنَ نَبِيِّكَ فَقُلْتِ يَا اَيُّهَا الَّذِيْنَ اٰمَنُوا لَا تَدْخُلُوْا
بُيُوْتِ النَّبِيِّ اِلَّا اَنْ يُؤْذَنْ لَكُمْ اَللّٰهُمَّ يَا اَيُّهَا الَّذِيْنَ
اٰمَنُوا لَا تَدْخُلُوْا بُيُوْتِ النَّبِيِّ اِلَّا اَنْ يُؤْذَنْ لَكُمْ اَللّٰهُمَّ وَاِنِّى
اَعْتَقِدُهَا فِىْ غَيْبَتِهِ كَمَا اَعْتَقَدُهَا فِىْ حَضْرَتِهِ وَاَعْلَمُ اَنَّ
رَسُوْلَكَ وَخَلْفَتَكَ عَلَيْهِمُ السَّلَامُ اَحْيَاءٌ عِنْدَكَ يُرَزَقُوْنَ يَرَوْنَ
مَقَامِى وَيَسْمَعُوْنَ كَلَامِى وَيُرَدُّوْنَ سَلَامِى وَاَنْتَ حَجَّبْتَ
عَنْ سَمْعِى كَلَامَهُمْ وَقَتَحْتَ بَابَ فَهْمِى بِلَدِيْذِ مَنْاَجَاتِهِمْ
وَاِنِّى اَسْتَنْدِيْكَ يَا رَبَّ اَوَّلًا وَاَسْتَنْدِيْكَ رَسُوْلَكَ صَلَّى اللّٰهُ
عَلَيْهِ وَاٰلِهٖ وَسَلَّمَ وَاَسْتَنْدِيْكَ خَلِيْفَتَكَ الْاِمَامَ الْمُفْتَرَضَ عَلَیَّ

In Prophet's Mosque

طَاعَتُهُ وَأَمَلَاتِكَ الْمُؤَكِّدِينَ بِهِدِهِ الْبُقْعَةَ الْمُبَارَكَةَ ثَابِتًا
ءَادْخُلُ يَارَسُولَ اللَّهِ ءَادْخُلْ يَا حُجَّةَ اللَّهِ ءَادْخُلْ
يَا مَلَاتِكَ اللَّهُ الْمُقَرَّبِينَ الْمُقِيمِينَ فِي هَذَا الْمَشْهَدِ فَأَذِّنْ
لِي يَا مُؤَلَّيَّ فِي الدُّخُولِ أَفْضَلَ مَا أذِنْتَ لِأَخِي مِنْ
أَوْيَاتِكَ فَإِنَّ لَمْ أَكُنْ أَهْلًا بِذَلِكَ فَانْتَ أَهْلٌ بِذَلِكَ

O Allah, I am standing at the door of one of the houses of Your Prophet and the family of Your Prophet, peace be upon him and his family. You have prohibited the people from entering his house except by the permission of Your Prophet and You said: "O You who believe do not enter the house of the Prophet unless permitted to do so". O Allah, I believe in this in his absence just as I believe it in his presence and I know that Your Prophet and Your vicegerents upon whom be peace, are alive in Your presence, they are being nourished, they see my position and hear my speech and they return my greetings and [I believe] that You have covered my ears from hearing their speech and have opened the door of perception of their secret conversations [with You]; I seek Your permission, O my Lord firstly; then I seek the permission of Your Prophet, peace be upon him and his family secondly and I seek the permission of Your

In Prophet's Mosque

vicegerent, the Imam whose obedience is incumbent upon me and [the permission of] Your angels entrusted over this blessed site thirdly. May I enter, O Prophet of Allah, May I enter O the proof of Allah, May I enter, O angels of Allah who are stationed close to this shrine, so permit me O my master to enter the best way that You have permitted any of Your friends, if I am not deserving of that then You surely are deserving of that.

Whilst putting your right foot in the haram read this:

بِسْمِ اللَّهِ وَبِاللَّهِ وَفِي سَبِيلِ اللَّهِ وَعَلَى مِلَّةِ رَسُولِ اللَّهِ صَلَّى
اللَّهُ عَلَيْهِ وَآلِهِ وَسَلَّمَ اغْفِرْ لِي وَارْحَمْنِي وَتُبْ عَلَيَّ إِنَّكَ
أَنْتَ التَّوَّابُ الرَّحِيمُ

In the name of Allah and by Allah in the path of Allah and on the religion of the Prophet of Allah peace be upon him and his family. O Allah forgive me and have mercy on me and turn repentant towards me for You are most forgiving and merciful.

Then say **اللَّهُ أَكْبَرُ** Allah is greatest 100 times and two rak'a prayer of greetings (tahiyyat) to the mosque.

Ziyarat of Prophet

Recite the Ziyarat of the Prophet of Allah as follows:

أَسْلَامُ عَلَيْكَ يَا رَسُولَ اللَّهِ أَسْلَامٌ عَلَيْكَ يَا نَبِيَّ اللَّهِ أَسْلَامٌ
عَلَيْكَ يَا خَاتِمَ النَّبِيِّينَ أَشْهَدُ أَنَّكَ قَدْ بَلَغْتَ الرِّسَالََةَ وَأَقَمْتَ
الصَّلَاةَ وَآتَيْتَ الزَّكَاةَ وَأَمَرْتَ بِالْمَعْرُوفِ وَنَهَيْتَ عَنِ الْمُنْكَرِ
وَعَبَدْتَ اللَّهَ مُخْلِصًا حَتَّى آتَاكَ الْيَقِينَ فَصَلِّوَاتِ اللَّهِ عَلَيْكَ
وَرَحْمَتِهِ وَعَلَى أَهْلِ بَيْتِكَ الطَّاهِرِينَ

Peace be upon you, O Messenger of Allah, Peace be upon you, O Prophet of Allah. Peace be upon you, O Muhammad the son of the 'Abd Allah. Peace be upon you, O seal of the Prophets; I bear witness that you proclaimed the message and established the prayer and paid the zakat and enjoined the good and forbade evil and worshipped Allah with all sincerity until death overtook you; so may the blessings and mercy of Allah be upon you and on your pure family.

Facing the Ka'ba towards the minbar read:

أَشْهَدُ أَنْ لَا إِلَهَ إِلَّا اللَّهُ وَحْدَهُ لَا شَرِيكَ لَهُ وَأَشْهَدُ أَنَّ مُحَمَّدًا
عَبْدُهُ وَرَسُولُهُ وَأَشْهَدُ أَنَّكَ رَسُولُ اللَّهِ وَأَنَّكَ مُحَمَّدُ بْنُ
عَبْدِ اللَّهِ وَأَشْهَدُ أَنَّكَ قَدْ بَلَغْتَ رِسَالَاتِ رَبِّكَ وَنَصَحْتَ

Ziyarat of Prophet

لَأَمَّتِكَ وَجَاهَدْتَ فِي سَبِيلِ اللَّهِ وَعَبَدْتَ اللَّهَ حَتَّى آتَاكَ
الْيَقِينَ بِالْحِكْمَةِ وَالْمَوْعِظَةِ الْحَسَنَةِ وَأَدَيْتَ الَّذِي عَلَيْكَ
مِنَ الْحَقِّ وَأَنَّكَ قَدْ رُوِّفْتَ بِالْمُؤْمِنِينَ وَعَلَّظْتَ عَلَى
الْكَافِرِينَ فَبَلَغَ اللَّهُ بِكَ أَفْضَلَ شَرَفٍ مَحَلِّ الْمَكْرَمِينَ
الْحَمْدُ لِلَّهِ الَّذِي اسْتَقْدَنَا بِكَ مِنَ الشَّرِّكَ وَالصَّلَاةِ اللَّهُمَّ
فاجعل صلواتك وصلوات ملائكتك المقرَّبين وأنبياءك
المرسلين وعبادك الصالحين أهل السموات والأرضين
ومن سبح لك يا رب العالمين من الأولين والآخرين على
محمدٍ عبدك ورسولك ونبيك وأمينك وحبيبك وخبيبتك
وصفيك وخاصيتك وصفوتك وخيرتك من خلقك اللهم
اعطه الدرجة الرفيعة وآتِه الوسيلة من الجنة وأبعثه مقاماً
مخموراً يغبطه به الأولون والآخرون اللهم إنك قلت ولو
أنهم إذ ظلموا أنفسهم جاءوك فاستغفروا الله واستغفر لهم
الرسول لوجدوا الله تواباً رحيماً وأنى آتيتك مستغفراً تائباً

Ziyarat of Prophet

مِن ذُنُوبِي وَأَنَّى اتَّوَجَّهُ بِكَ إِلَى اللَّهِ رَبِّي وَرَبِّكَ يَغْفِرْ لِي
ذُنُوبِي

I bear witness that there is no god except Allah He is unique, there is no partner unto Him and I bear witness that Muhammad is His slave and Prophet. I bear witness that you are the Prophet of Allah and that you are Muhammad, the son of 'Abd Allah and I bear witness that you proclaimed the messages of your Lord and that you advised your people and strived in the path of Allah and you served your Lord with wisdom and beautiful preaching until death overtook you; and you fulfilled the duty imposed on you and that you were kind to the believers and severe on the disbelievers. Allah has made you attain the highest position of honour and nobility.

Praise be to Allah who, through you, has saved us from polytheism and from going astray; O Allah, send Your blessings and the blessings of Your close angels and Your Messengers and those of Your upright slaves and the people of the heavens and the earth and those who have glorified You, O Lord, from the beginning to the end, on Muhammad Your slave and Messenger and Your Prophet and Your trustworthy and saved one, Your beloved and Your chosen one; Your special, pure and most virtuous one from Your creatures. O Allah, grant him an elevated status and make him a means to heaven and raise him in a praiseworthy status which the first and the last people will wish to attain. O Allah, You have

118

Ziyarat AL-Wida'

said: "If they wrong themselves and come to you and seek forgiveness from Allah, and if the Prophet seeks forgiveness for them, they will find Allah forgiving and merciful". I have come to you seeking forgiveness, repenting my sins and I seek your mediation with Allah, who is my Lord and your Lord that He forgives my sins.

At Maqame Jibra'il, recite the following:

أَسْأَلُكَ أَيُّ جِوَادٍ أَيُّ كَرِيمٍ أَيُّ قَرِيبٍ أَيُّ بَعِيدٍ أَنْ تَقْرُبَ
عَلَيَّ نِعْمَتَكَ

I ask You O generous one, O noble one O close one O distant one that You bestow Your favours on me again.

When leaving Medina, recite the following Ziyarat al-wida' (farewell ziyarat) of the Prophet:

السَّلَامُ عَلَيْكَ يَا رَسُولَ اللَّهِ اسْتَوْعِدْكَ وَأَسْتَرْعِيكَ وَأَقْرَبُ
عَلَيْكَ السَّلَامُ آمَنْتُ بِاللَّهِ وَبِمَا جِئْتَ بِهِ وَدَلَلْتَ عَلَيهِ اللَّهُمَّ
لَا تَجْعَلْهُ آخِرَ الْعَهْدِ مِنِّي لِزِيَارَةِ قَبْرِ نَبِيِّكَ فَإِنْ تَوَفَّيْتَنِي قَبْلَ
ذَلِكَ فَإِنِّي أَشْهَدُ فِي مَمَاتِي عَلَى مَا شَهِدْتَ عَلَيْهِ فِي

119

Ziyarat Al-Wida'

حَيَاتِي أَنْ لِأَنَّهُ إِذَا لَأَنْتَ وَأَنْ مُحَمَّدًا عَبْدَكَ وَرَسُولَكَ صَلَّى
اللَّهُ عَلَيْهِ وَآلِهِ

Peace be upon you O Prophet of Allah I bid you farewell and I ask you [for help] and I send you my salaams. I believe in Allah and in what you have brought and guided me towards. O Allah, do not make it my last visit to the grave of Your Prophet. If You take me away before that I bear witness in my death as I bear witness in my life that there is no god but You and that Muhammad is Your slave and Your Messenger peace be upon him and his family.

Ziyarat of Fatima

The Ziyarat of Fatima al-Zahra (peace be upon her):

السَّلَامُ عَلَيْكَ يَا بِنْتَ رَسُولِ اللَّهِ السَّلَامُ عَلَيْكَ يَا بِنْتَ نَبِيِّ
اللَّهِ السَّلَامُ عَلَيْكَ يَا بِنْتَ حَبِيبِ اللَّهِ السَّلَامُ عَلَيْكَ يَا بِنْتَ
خَلِيلِ اللَّهِ السَّلَامُ عَلَيْكَ يَا بِنْتَ صَفِيِّ اللَّهِ السَّلَامُ عَلَيْكَ
يَا بِنْتَ أَمِينِ اللَّهِ السَّلَامُ عَلَيْكَ يَا بِنْتَ خَيْرِ خَلْقِ اللَّهِ السَّلَامُ
عَلَيْكَ يَا بِنْتَ أَفْضَلِ أَنْبِيَاءِ اللَّهِ وَرُسُلِهِ وَمَلَائِكَتِهِ السَّلَامُ
عَلَيْكَ يَا بِنْتَ خَيْرِ الْبَرِيَّةِ السَّلَامُ عَلَيْكَ يَا سَيِّدَةَ نِسَاءِ
الْعَالَمِينَ مِنَ الْأَوَّلِينَ وَالْآخِرِينَ السَّلَامُ عَلَيْكَ يَا رُوحَةَ وَلِيِّ
اللَّهِ وَخَيْرِ خَلْقِ اللَّهِ بَعْدَ رَسُولِ اللَّهِ السَّلَامُ عَلَيْكَ يَا أُمَّ
الْحَسَنِ وَالْحُسَيْنِ سَيِّدِي شَبَابِ أَهْلِ الْجَنَّةِ السَّلَامُ عَلَيْكَ
أَيَّتُهَا الصَّدِّيقَةُ الشَّهِيدَةُ السَّلَامُ عَلَيْكَ أَيَّتُهَا الْفَاضِلَةُ الزَّكِيَّةُ
السَّلَامُ عَلَيْكَ أَيَّتُهَا الْحَوْرَاءُ الْإِنْسِيَّةُ السَّلَامُ عَلَيْكَ أَيَّتُهَا
التَّيَّةُ النُّقِيَّةُ السَّلَامُ عَلَيْكَ أَيَّتُهَا الْمُحَدَّثَةُ الْعَيْمَةُ السَّلَامُ
عَلَيْكَ أَيَّتُهَا الْمَظْلُومَةُ الْمَغْضُوبَةُ السَّلَامُ عَلَيْكَ أَيَّتُهَا
المُظْهِدَةُ الْمُقَهَّورَةُ السَّلَامُ عَلَيْكَ يَا فَاطِمَةَ بِنْتَ رَسُولِ

اللَّهُ وَرَحْمَةُ اللَّهِ وَبَرَكَاتُهُ صَلَّى اللَّهُ عَلَيْكَ وَعَلَى رُوحِكَ
وَبَدَنِكَ أَشْهَدُ أَنَّكَ مَصِيبَتِي عَلَى بَيْنَةٍ مِنْ رَبِّكَ وَأَنَّ مِنْ
سِرِّكَ فَقَدْ سَرَّ رَسُولَ اللَّهِ صَلَّى اللَّهُ عَلَيْهِ وَآلِهِ وَمَنْ جَفَاكَ
فَقَدْ جَفَا رَسُولَ اللَّهِ صَلَّى اللَّهُ عَلَيْهِ وَآلِهِ وَمَنْ آذَاكَ فَقَدْ
آذَى رَسُولَ اللَّهِ صَلَّى اللَّهُ عَلَيْهِ وَآلِهِ وَمَنْ وَصَلَكَ فَقَدْ
وَصَلَ رَسُولَ اللَّهِ صَلَّى اللَّهُ عَلَيْهِ وَآلِهِ وَمَنْ قَطَعَكَ فَقَدْ
قَطَعَ رَسُولَ اللَّهِ صَلَّى اللَّهُ عَلَيْهِ وَآلِهِ لَأَنَّكَ بَضْعَةٌ مِنْهُ
وَرُوحُهُ الَّذِي بَيْنَ جَنبَيْهِ أَشْهَدُ اللَّهُ وَرُسُلُهُ وَمَلَائِكَتُهُ أَنِّي
رَاضٍ عَمَّنْ رَضِيَ عَنْهُ سَاخِطٌ عَلَى مَنْ سَخِطَ عَلَيْهِ
مُتَبَرِّءٌ مِمَّنْ تَبَرَّأَتْ مِنْهُ مَوَالٍ لِمَنْ وَالَيْتَ مُعَادٍ لِمَنْ عَادَيْتَ
مُبْغِضٌ لِمَنْ أَبْغَضْتَ مُجِيبٌ لِمَنْ أَحْبَبْتَ وَكَفَى بِاللَّهِ شَهِيداً
وَخَبِيباً وَجَارِياً وَمُتَبِيباً

Peace be upon you O daughter of the Prophet of Allah,
peace be upon you O daughter of the Messenger of
Allah. Peace be upon You O daughter of the beloved of
Allah, Peace be upon you O daughter of the friend of
Allah, Peace be upon you O daughter of the chosen one
by Allah, Peace be upon you O daughter of the

trustworthy one of Allah, Peace be upon you O daughter
of the best of creation of Allah, Peace be upon you O
daughter of the best of the Prophets and Messengers and
angels of Allah. Peace be upon you O daughter of the
best of creation. Peace be upon you O leader of all
women in the world, from the beginning to the end;
Peace be upon you O wife of the friend of Allah and the
best of Allah's creation after the Prophet of Allah. Peace
be upon you O mother of al-Hasan and al-Husayn, the
two leaders of the youths in paradise. Peace be upon you
O truthful martyr, Peace be upon you O peaceful and
tranquil one. Peace be upon you O excellent and pure
one. Peace be upon you O one who has traits of an angel.
Peace be upon you O virtuous and pure one; Peace be
upon you O learned one who heard angels speak, Peace
be upon you O oppressed one and one whose rights were
usurped; Peace be upon you O one who was suppressed
and overpowered; Peace, mercy and blessings be upon
you O Fatima, the daughter of the Prophet of Allah. May
Allah bless you and your soul and body. I bear witness
that you passed away well informed by your Lord and
that one who has pleased you has pleased the Prophet of
Allah peace be upon him and his family; and one who
has displeased you has displeased the Prophet of Allah
peace be upon him and his family, and one who has
harassed you has harassed the Prophet of Allah peace be
upon him and his family and one who establishes links
with you establishes links with the Prophet of Allah
peace be upon him and his family and one who has cut

Ziyarat of Al-Baqi'i

relations with you has cut relations with the Prophet of Allah peace be upon him and his family because you are a part of him and of his spirit within him. I bear witness by Allah and His Prophets and His angels that I am pleased with one whom you are pleased and am angry with one whom you are angry, I dissociate myself from one whom you have dissociated yourself, I befriend myself with one whom you have befriended and am an enemy of one with whom you are an enemy; I detest one whom you detest, I love whom you love, Allah is sufficient as a witness and as one accounting for deeds and as one who repays and rewards.

Say the salawat followed by two rak'a namaz of Ziyarat and supplicate to Allah:

The Ziyarat of the Imams buried in al-Baqi'i:

السَّلَامُ عَلَيْكُمْ أئِمَّةَ الْهُدَى السَّلَامُ عَلَيْكُمْ أَهْلَ التَّقْوَى
السَّلَامُ عَلَيْكُمْ أَيُّهَا الْحُجَّجُ عَلَى أَهْلِ الدُّنْيَا السَّلَامُ عَلَيْكُمْ
أَيُّهَا الْقَوَامُ فِي الْبَرِيَّةِ بِالْقِسْطِ السَّلَامُ عَلَيْكُمْ أَهْلَ الصَّفْوَةِ
السَّلَامُ عَلَيْكُمْ آلَ رَسُولِ اللَّهِ السَّلَامُ عَلَيْكُمْ أَهْلَ النَّجْوَى
أَشْهَدُ أَنَّكُمْ قَدْ بَلَّغْتُمْ وَنَصَحْتُمْ وَصَبَرْتُمْ فِي ذَاتِ اللَّهِ
وَكُدِّبْتُمْ وَأُسِيبِي إِلَيْكُمْ فَغَفَرْتُمْ وَأَشْهَدُ أَنَّكُمْ الْأئِمَّةُ

Ziyarat of Al-Baqi'i

لرَأْسِدُونَ الْمُهْتَدُونَ وَأَنْ قَوْلَكُمْ الصِّدْقُ وَأَنَّكُمْ دَعْوَتُمْ فَلَمْ
تَجَابُوا وَأَمْرَتُمْ فَلَمْ تَطَاعُوا وَأَنَّكُمْ دَعَائِمُ الدِّينِ وَأَرْكَانُ
الْأَرْضِ لَمْ تَزَالُوا بَعِينِ اللَّهِ يَسْخُكُمْ مِنْ أَضْلَابِ كُلِّ مُظْهِرٍ
وَيَنْقَلِبُ مِنْ أَرْحَامِ الْمُظْهِرَاتِ لَمْ تُدَسِّسْكُمْ الْجَاهِلِيَّةُ
الْجَهْلَاءُ وَلَمْ تَشْرِكْ فِيكُمْ فِتْنُ الْأَهْوَاءِ طِبْتُمْ وَطَابَ مَسْبُكُكُمْ
مَنْ يَكُمُ عَلَيْنَا دِيَانُ الدِّينِ فَجَعَلَكُمْ فِي بُيُوتِ آذِنِ اللَّهِ أَنْ
تُرْفَعَ وَيَذْكَرَ فِيهَا اسْمُهُ وَجَعَلَ صَلَوَاتَنَا عَلَيْكُمْ رَحْمَةً لَنَا
وَكَفَّارَةً لِدُنُونِنَا إِذَا اخْتَارَكُمْ اللَّهُ لَنَا وَطَيَّبَ خَلْقَنَا بِمَا مَنَّ
عَلَيْنَا مِنْ وَلَايَتِكُمْ وَكُنَّا عِنْدَهُ مُسَمِّينَ بِعِلْمِكُمْ مَعْتَرِفِينَ
بِتَصْدِيقِنَا إِيَّاكُمْ وَهَذَا مَقَامٌ مِنْ أَسْرَفٍ وَأَخْطَأٍ وَاسْتِكَانٍ
وَأَقْرَبِمَا جَنَى وَرَجَى بِمَقَامِهِ الْخَلَاصِ وَأَنْ يَسْتَنْقِذَ الْهَلْكَى
مِنْ الرَّدَى فَكُونُوا لِي شَفَعَاءَ فَقَدْ وَفَدْتُ إِلَيْكُمْ إِذْ رَغِبَ
عَنكُمْ أَهْلُ الدُّنْيَا وَاتَّخَذُوا آيَاتِ اللَّهِ هُزُوعًا وَاسْتَكْبَرُوا عَنْهَا
يَا مَنْ هُوَ قَائِمٌ لَا يَسْهُوُ وَدَائِمٌ لَا يَلْهُوُ وَمُحِيطٌ بِكُلِّ شَيْءٍ لَكَ
الْمَنْ بِي مَا وَعَفْتَنِي وَعَرَفْتَنِي بِمَا أَقَمْتَنِي عَلَيْهِ إِذْ صَدَّ عَنْهُ

Ziyarat of Al-Baqi

عِبَادَكَ وَجَهْلُوا مَعْرِفَتَهُ وَاسْتَخَفُوا بِحَقِّهِ وَمَالُوا إِلَى سِوَاهُ
فَكَانَتْ أَلَمَةً مِنْكَ عَلَيَّ مَعَ أَقْوَامٍ خَصَصْتَهُمْ بِمَا خَصَصْتَنِي
بِهِ فَلَكَ الْحَمْدُ إِذْ كُنْتُ عِنْدَكَ فِي مَقَامِي هَذَا مَذْكُورًا
مَكْتُوبًا فَلَا تَخْرُجْنِي مَنَاجِرَتِي وَلَا تَخَيِّبْنِي فِيمَا دَعَوْتُ بِحُرْمَةِ
مُحَمَّدٍ وَآلِهِ الطَّاهِرِينَ وَصَلَّى اللَّهُ عَلَى مُحَمَّدٍ وَآلِ مُحَمَّدٍ

Peace be upon you O Imams of guidance, Peace be upon you O people of piety, Peace be upon you O proofs of Allah on the people of the earth; Peace be upon you who were steadfast in dealing with people with justice. Peace be upon you O people of the chosen one. Peace be upon you the family of the Prophet of Allah, Peace be upon you O people of secret conversations (with Allah), I bear witness that you proclaimed and advised and persevere Imam 'Ali (A.S. for the sake of Allah and that you were belied and evil was done to you and you forgave and I bear witness that you are the rightly guided leaders and that obedience to you is incumbent and that your speech is correct and that you invited [to the truth] but were not answered and you commanded but were not followed. I bear witness that you are the pillars of religion and support of the earth, you were always under the [caring]

Ziyarat of Al-Baqi

eyes of Allah who was transferring you from the wombs of the pure ones, the era of ignorance did not contaminate you; the sedition of desires has not partaken of you, you have become pure; your origin is pure. Through you He has favoured us [with His religion]. He has created You in houses in which Allah has allowed His name to be elevated and remembered. He has made our salutations to you to be a mercy for us and an expiation of our sins for Allah has chosen you for us and has made our creation pure because He has favoured us with your affection. We are named in front of Him due to your gnosis and because we acknowledged and believed in you. This is the position of one who has been extravagant and has erred; He has submitted and acknowledged what he has committed and hoped of his sincere position and through you he will be saved from destruction so be my intercessors. I have come to you for the people of the world have turned away from you and have taken the signs of Allah as jest and have become arrogant. O One who is upright and does not overlook; O Eternal One who does not disregard and covers all things You have favoured me with Your help and have shown me the path which You established for me; for Your slaves have turned away from it and have become ignorant of its knowledge and have belittled its rights and have inclined to others; it is Your favour on me with

Ziyarat of Al-Baqi

the people that You have chosen them as You have chosen me; so praise be to You for I am in front of You in this position remembered and subject to [Your] decree so do not deprive me of what I hoped for and, by the sanctity of Muhammad and his pure family, do not disappoint me what I have asked from You, send Your blessings on Muhammad and the family of Muhammad.

When leaving Jannat al-Baqi'i for the last time, recite this farewell Ziyarat (Ziyarat al-Wida'a)

السَّلَامُ عَلَيْكُمْ أَيَّمَةَ الْهُدَى وَرَحْمَةَ اللَّهِ وَبَرَكَاتِهِ أَسْتَوْعِدُّكُمْ
اللَّهُ وَأَقْرَأُ عَلَيْكُمْ السَّلَامَ. آمَنَّا بِاللَّهِ وَبِالرَّسُولِ وَبِمَا جِئْتُمْ بِهِ
وَدَلَّلْتُمْ عَلَيْهِ اللَّهُمَّ فَارْتَبْنَا مَعَ الشَّاهِدِينَ

Peace be upon you of leaders of guidance, may the mercy and blessings of Allah be showered upon you; I bid you farewell and send you my salutations. We have believed in Allah and in the Prophet and in what you have brought and guided towards. O my Allah, count us amongst those who bore witness [to this testimony].

Ziyarat of Ibrahim

The Ziyarat of Hazrat Ibrahim son of the Prophet:

السَّلَامُ عَلَى رَسُولِ اللَّهِ السَّلَامُ عَلَى نَبِيِّ اللَّهِ السَّلَامُ عَلَى
حَبِيبِ اللَّهِ السَّلَامُ عَلَى صَفِيِّ اللَّهِ السَّلَامُ عَلَى نَجِيِّ اللَّهِ
السَّلَامُ عَلَى مُحَمَّدِ بْنِ عَبْدِ اللَّهِ سَيِّدِ الْأَنْبِيَاءِ وَخَاتَمِ
الرُّسُلِينَ وَخَيْرِ اللَّهِ مِنْ خَلْقِهِ فِي أَرْضِهِ وَسَمَائِهِ وَرُسُلِهِ
السَّلَامُ عَلَى جَمِيعِ أَنْبِيَائِهِ وَرُسُلِهِ السَّلَامُ عَلَى الشُّهَدَاءِ
وَالسُّعْدَاءِ وَالصَّالِحِينَ السَّلَامُ عَلَيْنَا وَعَلَى عِبَادِ اللَّهِ
الصَّالِحِينَ السَّلَامُ عَلَيْكَ أَيُّهَا الرُّوحُ الزَّائِيَةُ السَّلَامُ عَلَيْكَ
أَيُّهَا النَّفْسُ الشَّرِيفَةُ السَّلَامُ عَلَيْكَ أَيُّهَا السَّلَالَةُ الطَّاهِرَةُ
السَّلَامُ عَلَيْكَ أَيُّهَا النَّسْمَةُ الزَّائِيَةُ السَّلَامُ عَلَيْكَ يَا بِنَّ خَيْرِ
الْوَرَى السَّلَامُ عَلَيْكَ يَا بِنَّ الْبَشِيرِ النَّذِيرِ السَّلَامُ عَلَيْكَ يَا بِنَّ
السَّرَّاجِ الْمُنِيرِ السَّلَامُ عَلَيْكَ يَا بِنَّ الْمُؤَيَّدِ بِالْقُرْآنِ السَّلَامُ
عَلَيْكَ يَا بِنَّ الْمُرْسَلِ إِلَى الْإِنْسِ وَالْجَنِّ السَّلَامُ عَلَيْكَ
يَا بِنَّ صَاحِبِ الرَّأْيَةِ وَالْعَلَامَةِ السَّلَامُ عَلَيْكَ يَا بِنَّ الشَّفِيعِ
يَوْمَ الْقِيَامَةِ السَّلَامُ عَلَيْكَ يَا بِنَّ مَنْ حَبَاهُ اللَّهُ بِالْكَرَامَةِ

السَّلَامُ عَلَيْكَ وَرَحْمَةُ اللَّهِ وَبَرَكَاتُهُ أَشْهَدُ أَنَّكَ قَدْ اخْتَارَ اللَّهُ
لَكَ دَارَ انْعَامِهِ قَبْلَ أَنْ يَكْتُبَ عَلَيْكَ أَحْكَامَهُ أَوْ يَكْلِفَكَ
خَلَالَهُ وَحَرَامَهُ فَتَنَّقَلْ إِلَيْهِ طَيْباً زَاكِياً مُرَضِئاً طَاهِراً مِنْ كُلِّ
نَجْسٍ مُقَدَّساً مِنْ كُلِّ دَنَسٍ وَبِوَتِّكَ جَنَّةَ الْمَأْوَى وَرَفَعَكَ
إِلَى الدَّرَجَاتِ الْعُلَى وَصَلَّى اللَّهُ عَلَيْكَ صَلَوةً تَقْرُبُهَا عَيْنُ
رَسُولِهِ وَتَبْلُغُهُ أَكْبَرَ مَأْمُومِيهِ اللَّهُمَّ اجْعَلْ أَفْضَلَ صَلَواتِكَ
وَأَزْكَىهَا وَأَنْمَى بَرَكَاتِكَ وَأَوْفَاهَا عَلَى رَسُولِكَ وَنَبِيِّكَ
وَخَيْرَتِكَ مِنْ خَلْقِكَ مُحَمَّدٍ خَاتِمِ النَّبِيِّينَ وَعَلَى مَنْ نَسَلَ
مِنْ أَوْلَادِهِ الطَّيِّبِينَ وَعَلَى مَنْ خَلَفَ مِنْ عِتْرَتِهِ الطَّاهِرِينَ
بِرَحْمَتِكَ يَا رَحِمَ الرَّاحِمِينَ اللَّهُمَّ إِنِّي أَسْئَلُكَ بِحَقِّ
مُحَمَّدٍ صَفِيِّكَ وَإِبْرَاهِيمَ نَجْلِ نَبِيِّكَ أَنْ تَجْعَلَ سَعْيِي بِهِمْ
مَشْكُوراً وَذَنْبِي بِهِمْ مَغْفُوراً وَحَيَاتِي بِهِمْ سَعِيدَةً وَعَاقِبَتِي
بِهِمْ خَيْرَةً وَحَوَائِجِي بِهِمْ مُقْضِيَةً وَأَفْعَالِي بِهِمْ مُرْضِيَةً
وَأُمُورِي بِهِمْ مَسْعُودَةً وَسُنُونِي بِهِمْ مَحْمُودَةً اللَّهُمَّ وَأَخْسِنْ
لِي التَّوْفِيقَ وَنَفْسَ عَنِّي كُلَّ هَمٍّ وَضِيقٍ اللَّهُمَّ جَنِّبْنِي

عِقَابِكَ وَأَمْنِجْنِي ثَوَابِكَ وَأَسْكِنِي جَنَّاتِكَ وَأَرْزُقْنِي
رِضْوَانِكَ وَأَمَّا نَاكَ وَأَشْرِكْ فِي صَلَاحِ دُعَائِي وَالَّذِي وُودِي
وَجَمِيعِ الْمُؤْمِنِينَ وَالْمُؤْمِنَاتِ الْأَحْيَاءِ مِنْهُمْ وَالْأَمْواتِ إِنَّكَ
وَلِي الْبَاقِيَاتِ الصَّالِحَاتِ آمِينَ رَبَّ الْعَالَمِينَ

Peace be on the Prophet of Allah, Peace be on the Messenger of Allah, Peace be on the beloved of Allah, Peace be on the chosen one of Allah, Peace be on the saved one by Allah, Peace be on Muhammad the son of 'Abd Allah, the master and seal of the Prophets and the chosen one by Allah amongst all His creatures on the earth and skies. Peace be on all His Prophets and Messengers; Peace be on the martyrs and upright prosperous one. Peace be on us and on the upright slaves of Allah. Peace be on you O pure soul; Peace be on you O noble self; Peace be on you, O one with pure descent; Peace be on you, O pure soul. Peace be on you, O son of the best creatures; Peace be on you O son of the chosen Prophet, Peace be on you O son of one sent to all the upright ones; Peace be on you, O son of the bringer of good tidings and warmer; Peace be on you, O son of the lamp and light. Peace be upon you, O son of one supported by the Qur'an; Peace be on you O son of one sent to human beings and Jinns; Peace be on you O son

Ziyarat of Ibrahim

of one supported by the Qur'an; Peace be on you O son of one sent to human beings and Jinns; Peace be on you O son of the bearer of the flag and sign; Peace be on you O son of the intercessor on the day of judgement; Peace be on you O son of one whom Allah drew closer with honour; Peace be on you, and may the mercy and blessings of Allah descend upon you I bear witness that Allah has chosen for you the abode of His blessings before He prescribed His laws or imposed His halal and haram so He took you towards Him as were good, pure, contented and purified from all impurity, sanctified from all filth and He has allocated heaven as your resting abode and elevated you to a high station; May the blessings of Allah be upon you, blessings through which the eyes of His Prophet are delighted and his greatest hopes realized. O Allah, send Your best, pure and choicest and complete blessings on Your Prophet and Messenger and Your choicest of creatures Muhammad the seal of the Prophets and on the loins of his pure sons and on those succeeding him from his pure family, by Your mercy, O Most Merciful One. O Allah, I ask You by the right of Muhammad Your chosen one and by Ibrahim, the progeny of Your Prophet that make my striving to them accepted, due to them, forgive my sins

132

Ziyarat of Fatima Bint Asad

and make my life, due to them, upright and my end, due to them, praiseworthy, my needs, due to them, fulfilled and my actions, due to them, pleasing [to You] and my affairs, due to them, prosperous and my matters, due to them, commendable. O Allah, make my success complete, and free me from all troubles and constraints. O Allah, remove Your punishment from me and grant me Your rewards; make me live in Your paradise, grant me Your pleasure and Your safety; include in my upright supplication my parents and my children and all the believers, men and women, those alive or dead, for You are the master of the actions which survive after the doer passes away, Amin, O Lord of the universe.

Ziyarat of Janab Fatima bint Asad, mother of Imam 'Ali (A.S.)

السَّلَامُ عَلَى نَبِيِّ اللَّهِ السَّلَامُ عَلَى رَسُولِ اللَّهِ السَّلَامُ عَلَى مُحَمَّدٍ سَيِّدِ الْمُرْسَلِينَ السَّلَامُ عَلَى مُحَمَّدٍ سَيِّدِ الْأَوْلِيَاءِ السَّلَامُ عَلَى مُحَمَّدٍ سَيِّدِ الْأَخِيرِينَ السَّلَامُ عَلَى مَنْ بَعَثَهُ اللَّهُ رَحْمَةً لِلْعَالَمِينَ السَّلَامُ عَلَيْكَ أَيُّهَا النَّبِيُّ وَرَحْمَةُ اللَّهِ وَبَرَكَاتُهُ السَّلَامُ عَلَى فَاطِمَةَ بِنْتِ أَسَدِ الْأَهْلِ الشَّيْمِيَّةِ السَّلَامُ

133

عَلَيْكَ أَيُّهَا الصَّادِقَةُ الْمَرْضِيَّةُ السَّلَامُ عَلَيْكَ أَيُّهَا النَّبِيَّةُ
التَّقِيَّةُ السَّلَامُ عَلَيْكَ أَيُّهَا الْكَرِيمَةُ الرَّضِيَّةُ السَّلَامُ عَلَيْكَ
يَا كَافِلَةَ مُحَمَّدٍ خَاتِمِ النَّبِيِّينَ السَّلَامُ عَلَيْكَ يَا وَالِدَةَ سَيِّدِ
الْوَصِيِّينَ السَّلَامُ عَلَيْكَ يَا مَنْ ظَهَرَتْ شَفَقَتُهَا عَلَى رَسُولِ
اللَّهِ خَاتِمِ النَّبِيِّينَ السَّلَامُ عَلَيْكَ يَا مَنْ تَرَبَّيْتُهَا لِبُوْلِیِ اللَّهِ
الْأَمِينِ السَّلَامُ عَلَيْكَ وَعَلَى رُوحِكَ وَبَدَنِكَ الطَّاهِرِ السَّلَامُ
عَلَيْكَ وَعَلَى وَلَدِكَ وَرَحْمَةِ اللَّهِ وَتَرَكَاتِهِ أَشْهَدُ أَنَّكَ أَحْسَنْتِ
الْكِفَالََةَ وَأَدَيْتِ الْأَمَانَةَ وَاجْتَهَدْتِ فِي مَرْضَاتِ اللَّهِ وَبَالَغْتِ
فِي حِفْظِ رَسُولِ اللَّهِ عَارِفَةَ حَقِّهِ مُؤْمِنَةً بِصَدَقِهِ مُعْتَرِفَةً
بُنُبُوْتِهِ مُسْتَبْصِرَةً بِعِزَّتِهِ كَافِلَةَ بَرِّيَّتِهِ مُشْفِقَةً عَلَى نَفْسِهِ
وَأَقْفَةَ عَلَى خِدْمَتِهِ مُخْتَارَةً رِضَاهُ وَمُؤَيَّرَةً هَوَاهُ وَأَشْهَدُ أَنَّكَ
مَضَيْتِ عَلَى الْإِيْمَانِ وَالتَّمَسُّكِ بِأَشْرَفِ الْأَدْبَانِ رَاضِيَةً
مَرْضِيَّةً طَاهِرَةً زَكِيَّةً تَقِيَّةً فَرَضَى اللَّهُ عَنْكَ وَأَرْضَاكَ
وَجَعَلَ الْجَنَّةَ مَنْزِلَكَ وَمَاوِيكَ اللَّهُمَّ صَلِّ عَلَى مُحَمَّدٍ وَآلِ
مُحَمَّدٍ وَانْفَعْنِي بِزِيَارَتِهَا وَتَبَيَّنِّي عَلَى مَحَبَّتِهَا وَلَا تَحْرِمْنِي

شَفَاعَتِهَا وَشَفَاعَةَ الْأَيْمَةِ مِنْ ذُرِّيَّتِهَا وَأَرْزُقْنِي مَرَاقِفَتِهَا
وَاحْشُرْنِي مَعَهَا وَمَعَ أَوْلَادِهَا الطَّاهِرِينَ اللَّهُمَّ لِاتِّجَلِّهِ آخِرَ
العَهْدِ مِنْ زِيَارَتِي أَيُّهَا وَأَرْزُقْنِي العُودَ إِلَيْهَا أَبَدًا مَا أَبْقَيْتَنِي
وَإِذَا تَوَفَّيْتَنِي فَاحْشُرْنِي فِي زَمَرَتِهَا وَأَدْخِلْنِي فِي شَفَاعَتِهَا
بِرَحْمَتِكَ يَا أَرْحَمَ الرَّاحِمِينَ اللَّهُمَّ بِحَقِّهَا عِنْدَكَ وَمَنْزِلَتِهَا
لَدَيْكَ اغْفِرْ لِي وَلِوَالِدِي وَلِجَمِيعِ الْمُؤْمِنِينَ وَالْمُؤْمِنَاتِ
وَأَيُّنَا فِي الدُّنْيَا حَسَنَةً وَفِي الْآخِرَةِ حَسَنَةً وَقِنَا بِرَحْمَتِكَ
عَذَابَ النَّارِ

Peace be on the Prophet of Allah, peace be on the Messenger of Allah, peace be on Muhammad the leaders of the Messengers, peace be on Muhammad the leader of the foremost ones, peace be on Muhammad, the leader of the last ones. Peace be on one whom Allah sent as a mercy to the universe. Peace be on you, O Prophet and may the mercy and blessings of Allah be upon you. Peace be on Fatima, the daughter of Asad, the Hashimite, Peace be upon you O truthful and contented one; Peace be upon you O virtuous and pure one; Peace

Ziyarat of Fatima Bint Asad

be upon you O noble and contented one; Peace be upon you O one who looked after Muhammad, the seal of the Prophets. Peace be upon you O mother of the leader of the successors. Peace be upon you who showed compassion to the Prophet of Allah, seal of the Prophets; Peace be upon you O one who raised the trustworthy friend of Allah; Peace be upon you, on your soul and on your pure body; May peace, mercy and blessings be upon you and on your son. I bear witness that you supported in the best manner possible and fulfilled your obligation and strived for the pleasure of Allah and exerted yourself in protecting the Prophet of Allah, being aware of his status; believing in his truthfulness; acknowledging his prophecy, perceiving his blessings; taking responsibility of his upbringing, dealing with him affectionately; ready to serve him; choosing what pleased him, preferring what he liked; I bear witness that you spent your life on the [true] faith and adhering to the most noble religion, being pleased and contented, pure, clean, guarded and virtuous. May Allah be pleased and satisfied with you; May He make heaven as your house and permanent abode. O Allah, send your greetings on Muhammad and the family of Muhammad and make my visiting her beneficial to me and make me firm in my love for her and do not deprive me of her intercession and the intercession of the Imams from her loins; so grant me her company and gather me with her and with her pure children; O Allah, do not make it my last visit to her and grant me another visit to her as along as You

136

Ziyarat of Hamza

keep me alive and if You cause me to die then gather me with her ranks and include me amongst those receiving her intercession by Your mercy, O Most Merciful of the Merciful ones. O Allah, I ask You by her status and high position in front of You, forgive me and my parents and all believing men and women and grant us goodness in this and the next world and save us, by Your mercy, from the punishment of the fire.

The Ziyarat of Hazrat Hamza, the uncle of the Prophet (S.A.W) at Uhud:

السَّلَامُ عَلَيْكَ يَا أَسَدَ اللَّهِ وَأَبِيهِ السَّلَامُ
عَلَيْكَ يَا خَيْرَ الشُّهَدَاءِ السَّلَامُ عَلَيْكَ يَا اللَّهُ عَزَّ وَجَلَّ وَجُدْتَ
رَسُولَهُ أَشْهَدُ أَنَّكَ قَدْ جَاهَدْتَ فِي اللَّهِ عَزَّ وَجَلَّ وَجُدْتَ
بِنَفْسِكَ وَنَصَحْتَ رَسُولَ اللَّهِ وَكُنْتَ فِيمَا عِنْدَ اللَّهِ سُبْحَانَهُ
رَأِغِبًا يَا بِي أَنْتَ وَأُمِّي أَتَيْتُكَ مُتَّقِرًا إِلَى اللَّهِ عَزَّ وَجَلَّ
بِزِيَارَتِكَ وَمُتَّقِرًا إِلَى رَسُولِ اللَّهِ صَلَّى اللَّهُ عَلَيْهِ وَآلِهِ
بِذَلِكَ رَأِغِبًا إِلَيْكَ فِي الشَّفَاعَةِ أَبْتَغِي بِزِيَارَتِكَ خَلَاصَ
نَفْسِي مُتَعَوِّدًا بِكَ مِنْ نَارِ اسْتَحَقَّهَا مِثْلِي بِمَا جَنَيْتُ عَلَى
نَفْسِي هَارِبًا مِنْ ذُنُوبِي الَّتِي أَحْتَطَبْتُهَا عَلَى ظَهْرِي فَرِعَا

137

Ziyarat of Hamza

إِلَيْكَ رَجَاءٌ رَحْمَةً رَبِّي آتَيْتَكَ مِنْ شُقَّةٍ بَعِيدَةٍ طَالِبًا فَكَأَنَّكَ
رَقِيبِي مِنْ النَّارِ وَقَدْ أَوْقَرْتَ ظَهْرِي ذُنُوبِي وَأَتَيْتَ مَا
أَسْخَطَ رَبِّي وَلَمْ أَجِدْ أَحَدًا أَفْرَعُ إِلَيْهِ خَيْرًا لِي مِنْكُمْ أَهْلُ
بَيْتِ الرَّحْمَةِ فَكُنْ لِي شَفِيعًا يَوْمَ فِقْرِي وَحَاجَتِي فَقَدْ سِرْتُ
إِلَيْكَ مَخْرُوفًا وَأَتَيْتَكَ مَكْرُوبًا وَسَكَبْتُ عِبْرَتِي عِنْدَكَ يَا كَبِيرًا
وَصَوَّرْتُ إِلَيْكَ مُفْرَدًا وَأَنْتَ مِنْ أَمْرِنِي اللَّهُ بِصَلَاتِهِ وَحَنِينِي
عَلَى بَرِّهِ وَدَلِّينِي عَلَى فَضْلِهِ وَهَدَانِي لِحَبْلِهِ وَرَغْبَتِي فِي
الْوَفَادَةِ وَالْهَمْنِي طَلَبَ الْحَوَائِجِ عِنْدَهُ أَنْتُمْ أَهْلُ بَيْتِ
لَا يُشْفَى مَنْ تَوَلَّاهُمْ وَلَا يُخَيَّبُ مَنْ يَهْوَاهُمْ وَلَا يَسْعُدُ مَنْ
عَادَاهُمْ

Peace be upon you O uncle of the Prophet of Allah peace be upon him and his family; Peace be upon you O best of the martyrs; Peace be upon you O lion of Allah and the lion of His Prophet. I bear witness that you fought for Allah, the Most Mighty and Glorious and you exerted yourself and advised the Prophet of Allah and desired [the rewards] available through Allah the Most Glorious.

Ziyarat of Hamza

May my father and mother be sacrificed for you, I have come to you seeking closeness to Allah the Most Mighty and Glorious by visiting you, and seeking nearness to the Prophet of Allah peace be upon him and his family; through that desiring from you, [your] intercession; seeking from my visiting you freedom of my self and seeking refuge, through you, from the fire; those like me deserve it for the wrong I have done to myself. [I come] fleeing from my sins which I have committed; fleeing to you hoping for the mercy of my Lord; I have come to you from a distant land seeking freedom from the fire, my back is loaded with my sins. I have committed what angers my Lord. I did not find anyone more worthy to flee to than you, the ahl al-bayt of mercy, so be my intercessors on the day of my poverty and need. I have travelled to you in a sad state and in distress. I shed tears in front of you, crying I have come to you lonely; you are amongst those whom Allah has commanded to join with and has urged me towards piety and guided me to His grace and love; He urged me to come to you and inspired me to ask my needs to Him; You are the ahl al-bayt no one who befriends you is miserable; one who comes to you is not disappointed and one who is inclined towards you does not lose nor does one who shows enmity towards you become happy.

Ziyarat of Uhud

SAY TWO RAK'AT NAMAZ AND SAY DUA'S:
Ziyarat of Martyrs (Shuhada) of Uhud:

السَّلَامُ عَلَى رَسُولِ اللَّهِ السَّلَامُ عَلَى نَبِيِّ اللَّهِ السَّلَامُ عَلَى
مُحَمَّدِ بْنِ عَبْدِ اللَّهِ السَّلَامُ عَلَى أَهْلِ بَيْتِهِ الطَّاهِرِينَ
السَّلَامُ عَلَيْكُمْ أَيُّهَا الشُّهَدَاءُ الْمُؤْمِنُونَ السَّلَامُ عَلَيْكُمْ يَا أَهْلَ
بَيْتِ الْإِيمَانِ وَالتَّوَجِيدِ السَّلَامُ عَلَيْكُمْ يَا أَنْصَارَ دِينِ اللَّهِ
وَأَنْصَارَ رَسُولِهِ عَلَيْهِ وَآلِهِ السَّلَامُ سَلَامٌ عَلَيْكُمْ بِمَا صَبَرْتُمْ فِيهِمْ
عَقَبَى الدَّارِ أَشْهَدُ أَنَّ اللَّهَ اخْتَارَكُمْ لِدِينِهِ لِأَنَّكُمْ وَأَصْطَفَاكُمْ
لِرَسُولِهِ وَأَشْهَدُ أَنَّكُمْ قَدْ جَاهَدْتُمْ فِي اللَّهِ حَقَّ جِهَادِهِ
وَدَيْبْتُمْ عَنْ دِينِ اللَّهِ وَعَنْ نَبِيِّهِ وَجَدْتُمْ بِأَنْفُسِكُمْ دُونَهُ
وَأَشْهَدُ أَنَّكُمْ قُتِلْتُمْ عَلَى مَنَاجِجِ رَسُولِ اللَّهِ فَجَزَاكُمْ اللَّهُ
عَنْ نَبِيِّهِ وَعَنْ الْإِسْلَامِ وَأَهْلِهِ أَفْضَلَ الْجَزَاءِ وَعَرَفْنَا
وَجُوهَكُمْ فِي مَحَلِّ رِضْوَانِهِ وَمَوْضِعِ إِكْرَامِهِ مَعَ النَّبِيِّينَ
وَالصَّادِقِينَ وَالشُّهَدَاءِ وَالصَّالِحِينَ وَحَسُنَ أَوْلَايَاكَ رَفِيقاً
أَشْهَدُ أَنَّكُمْ جِزْبُ اللَّهِ وَأَنَّ مَنْ حَارَبَكُمْ فَقَدْ حَارَبَ اللَّهَ
وَأَنَّكُمْ لِمِنَ الْمُقَرَّبِينَ الْفَائِزِينَ الَّذِينَ هُمْ أَحْيَاءٌ عِنْدَ رَبِّهِمْ

Ziyarat of Uhud

يُرْزَقُونَ فَعَلَى مَنْ قَتَلَكُمْ لَعْنَةُ اللَّهِ وَالْمَلَائِكَةِ وَالنَّاسِ
أَجْمَعِينَ أَتَيْتُكُمْ يَا أَهْلَ التَّوَجِيدِ زَائِراً وَبِحَقِّكُمْ عَارِفاً
وَبِرْيَابِكُمْ إِلَى اللَّهِ مَتَقرباً وَبِمَا سَبَقَ مِنْ شَرِيفِ الْأَعْمَالِ
وَمَرْضِي الْأَفْعَالِ عَالِماً فَتَلِيكُمْ سَلَامٌ اللَّهُ وَرَحْمَتُهُ وَبَرَكَاتُهُ
وَعَلَى مَنْ قَتَلَكُمْ لَعْنَةُ اللَّهِ وَغَضَبُهُ وَسَخَطُهُ اللَّهُمَّ الْفَعْبَى
بِرْيَابِهِمْ وَبَيْتِي عَلَى قَصْدِهِمْ وَتَوْفِيئِي عَلَى مَا تَوْفَيْتَهُمْ عَلَيْهِ
وَاجْمَعِ بَيْنِي وَبَيْنَهُمْ فِي مُسْتَقَرِّ دَارِ رَحْمَتِكَ أَشْهَدُ أَنَّكُمْ لَنَا
قَرُوبٌ وَنَحْنُ بِكُمْ لِأَحِقُّونَ

Peace be on the Prophet of Allah, Peace be on the Messenger of Allah; Peace be on Muhammad the son of 'Abd Allah; Peace be on his pure family; Peace be on you O believing martyrs; Peace be on you, O people of the house of belief and unity; Peace be on you, O helpers of the religion of Allah and helpers of His Prophet and his family, Peace be on you for the patience which you have exercised for what a wonderful abode that is! I bear witness that Allah has chosen you for His religion and chosen you for His Prophet. I also bear witness that you truly strove for Allah and defended the religion of Allah and His Prophet and you gave

Ziyarat of Uhud

yourselves for him. I bear witness that you were killed on the path of the Prophet of Allah so may Allah grant you the best reward for [your services to] His Prophet and for Islam and its followers. May Allah make us see your faces in places of His pleasure and His honour with the Messengers and the truthful ones and the martyrs and the upright ones; for they are the best friends. I bear witness that you are the party of Allah and that one who wages war against you wages war against Allah. I also bear witness that you are the close, victorious ones to Allah who are living in the proximity of their Lord and are being nourished. May the curse of Allah and the angels and all the people fall on those who killed you. I have come to visit you, O People of tawhid, knowing your rights and the merits of visiting you seeking closeness to Allah. and because of my knowing [your] past honourable deeds and good acts so may the peace, mercy and blessings of Allah be upon you; may the curse, anger and wrath befall on one who killed you. O Allah, make my visit to them beneficial to me and me firm in my resolution [for them] and make me die [for the same goal] as you made them die and gather me and them in the same abode of your mercy. I bear witness that you have preceded us and we will join you.

Ziyarat of Al-Jami'a

RECITE SURA INNA ANZALNAH (SURA NO.97)
Ziyarat al-Jami'a

السَّلَامُ عَلَى أَوْلِيَاءِ اللَّهِ وَأَصْفِيَاءِهِ السَّلَامُ عَلَى أُمَّةِ اللَّهِ
وَأَجْيَائِهِ السَّلَامُ عَلَى أَنْصَارِ اللَّهِ وَخُلَفَائِهِ السَّلَامُ عَلَى مَحَالِّ
مَعْرِفَةِ اللَّهِ السَّلَامُ عَلَى مَسَاكِينِ ذِكْرِ اللَّهِ السَّلَامُ عَلَى
مُظْهِرِي أَمْرِ اللَّهِ وَنَهْيِهِ السَّلَامُ عَلَى الدُّعَاةِ إِلَى اللَّهِ السَّلَامُ
عَلَى الْمُسْتَقْرِبِينَ فِي مَرَضَةِ اللَّهِ السَّلَامُ عَلَى الْمُخْلِصِينَ
فِي طَاعَةِ اللَّهِ السَّلَامُ عَلَى الْأَوْلَاءِ عَلَى اللَّهِ السَّلَامُ عَلَى
الَّذِينَ مِنْ وَالَاهُمْ فَقَدْ وَالَى اللَّهُ وَمَنْ عَادَاهُمْ فَقَدْ عَادَى
اللَّهُ وَمَنْ عَرَفَهُمْ فَقَدْ عَرَفَ اللَّهُ وَمَنْ جَهَلَهُمْ فَقَدْ جَهَلَ اللَّهُ
وَمَنْ اعْتَصَمَ بِهِمْ فَقَدْ اعْتَصَمَ بِاللَّهِ وَمَنْ تَخَلَّى مِنْهُمْ فَقَدْ
تَخَلَّى مِنَ اللَّهِ عَزَّوَجَلَّ وَأَشْهَدُ اللَّهُ أَنِّي سَلِمْتُ لِمَنْ سَأَلْتَهُمْ
وَحَرْبُ يَمَنْ حَارَبْتَهُمْ مُؤْمِنٌ بِسِرِّكُمْ وَعَلَائِقِكُمْ مَفُوضٌ فِي
ذَلِكَ كُلِّهِ إِلَيْكُمْ لَعَنَ اللَّهُ عَدُوَّ آلِ مُحَمَّدٍ مِنْ الْجِنَّ
وَالْإِنْسِ وَأَبْرَأَ إِلَى اللَّهِ مِنْهُمْ وَصَلَّى اللَّهُ عَلَى مُحَمَّدٍ وَآلِهِ

Ziyarat of Al-Jami'a

Peace be on the friends and chosen ones of Allah; Peace be on the trustworthy ones of Allah and on those who love Him. Peace be on the helpers and vicegerents of Allah. Peace be on the place of repository of His knowledge. Peace be on the places of the remembrance of Allah. Peace be on where the commandments and prohibitions of Allah are manifested. Peace be on you who invite [others] to Allah, Peace be on you those who are established on the pleasure of Allah; Peace be on those who are sincere in the obedience of Allah; Peace be on the guides to Allah; Peace be on those who when one befriends them, he befriends Allah and when one is an enemy to them is an enemy to Allah; when one knows them he knows Allah and if one is ignorant of them he is ignorant of Allah, when one clings to them he clings to Allah when one goes from them, he goes from Allah the most Mighty and Glorious; I bear witness by Allah I am at peace with whom you are at peace and at war with whom you are at war, I believe in your secrecy and in openness, I entrust that all to you. May Allah curse the enemies of the family of Muhammad from amongst the jinns and humans and I disassociate by Allah from them, May Allah send his blessings on Muhammad and his family.

زِيَارَةُ الْإِمَامِ الْحَسَنِ بْنِ عَلِيٍّ (ع)

بِسْمِ اللَّهِ الرَّحْمَنِ الرَّحِيمِ

السَّلَامُ عَلَيْكَ يَا ابْنَ رَسُولِ اللَّهِ السَّلَامُ عَلَيْكَ يَا ابْنَ نَبِيِّ اللَّهِ السَّلَامُ عَلَيْكَ يَا ابْنَ أَمِيرِ الْمُؤْمِنِينَ السَّلَامُ عَلَيْكَ يَا ابْنَ فَاطِمَةَ الزُّهْرَاءِ السَّلَامُ عَلَيْكَ يَا ابْنَ خَدِيجَةَ الْكُبْرَى السَّلَامُ عَلَيْكَ يَا حَبِيبَ اللَّهِ السَّلَامُ عَلَيْكَ يَا صَفِيَّ اللَّهِ السَّلَامُ عَلَيْكَ يَا أَمِينَ اللَّهِ السَّلَامُ عَلَيْكَ يَا حُجَّةَ اللَّهِ السَّلَامُ عَلَيْكَ يَا نُورَ اللَّهِ السَّلَامُ عَلَيْكَ يَا صِرَاطَ اللَّهِ السَّلَامُ عَلَيْكَ يَا لِسَانَ حِكْمَةِ اللَّهِ السَّلَامُ عَلَيْكَ يَا نَاصِرَ دِينِ اللَّهِ السَّلَامُ عَلَيْكَ أَيُّهَا السَّيِّدُ الرَّكْبِيِّ السَّلَامُ عَلَيْكَ أَيُّهَا الْبُرِّ النَّبِيُّ السَّلَامُ عَلَيْكَ أَيُّهَا الْقَاتِمُ الْأَمِينُ السَّلَامُ عَلَيْكَ أَيُّهَا الْعَالِمُ بِالتَّوَالِيهِ السَّلَامُ عَلَيْكَ أَيُّهَا الْهَادِي الْمُهْدِي السَّلَامُ عَلَيْكَ أَيُّهَا الْبَاهِرُ الْخَفِيِّ السَّلَامُ عَلَيْكَ أَيُّهَا الطَّاهِرُ الرَّكْبِيُّ السَّلَامُ عَلَيْكَ أَيُّهَا الصِّدِّيقُ الشَّهِيدُ السَّلَامُ عَلَيْكَ أَيُّهَا الْحَقُّ الْحَقِيقُ السَّلَامُ عَلَيْكَ يَا مَوْلَايَ يَا أَبَا مُحَمَّدٍ الْحَسَنَ بْنَ عَلِيٍّ وَرَحْمَةَ اللَّهِ وَبَرَكَاتَهُ.

Ziyarat of Imam al-Hasan b. 'Ali (A.S.)

Peace be on You, O son of the Messenger of God, Peace be on You, O son of the Prophet of God, Peace be on You, O son of the Commander of the Faithful, Peace be on You, O son of Fatima al-Zahra, Peace be on You, O son of Khadija al-Kubra, Peace be on You, O the beloved of Allah, Peace be on You, O friend of Allah, Peace be on You, O representative of Allah, Peace be on You, O proof of Allah, Peace be on You, O light of Allah, Peace be on You, O the path towards Allah, Peace be on You, O tongue of the wisdom of Allah, Peace be on You, O the helper of the religion of Allah, Peace be on You, O the pure leader, Peace be on You, O virtuous, upright one, Peace be on You, O steadfast upright one. Peace be on You, O one who knew the correct interpretation (of the Qur'an), Peace be on You, O guide who is rightly guided, Peace be on You, O hidden splendor. Peace be on You, O the pure and chaste one, Peace be on You, O truthful martyr. Peace be on You, O most truthful one, Peace be on You, O my master, O Abu Muhammad al-Hasan b. 'Ali and may the mercy and blessings of Allah be upon you

زِيَارَةُ الْإِمَامِ زَيْنِ الْعَابِدِينَ (ع)

بِسْمِ اللَّهِ الرَّحْمَنِ الرَّحِيمِ

السَّلَامُ عَلَيْكَ يَا زَيْنَ الْعَابِدِينَ السَّلَامُ عَلَيْكَ يَا زَيْنَ الْمُجْتَهِدِينَ السَّلَامُ عَلَيْكَ يَا إِمَامَ التَّقِيْنَ السَّلَامُ عَلَيْكَ يَا وَلِيَّ الْمُسْلِمِينَ السَّلَامُ عَلَيْكَ يَا قُرَّةَ عَيْنِ النَّاطِرِينَ الْعَارِفِينَ السَّلَامُ عَلَيْكَ يَا خَلْفَ السَّابِقِينَ السَّلَامُ عَلَيْكَ يَا وَصِيَّ الوَصِيِّينَ السَّلَامُ عَلَيْكَ يَا خَازِنَ وَصَايَا الْمُرْسَلِينَ السَّلَامُ عَلَيْكَ يَا ضَوْءَ الْمُسْتَوْجِبِينَ السَّلَامُ عَلَيْكَ يَا نُورَ الْمُجْتَهِدِينَ السَّلَامُ عَلَيْكَ يَا سِرَاجَ الْمُرْتَاضِينَ السَّلَامُ عَلَيْكَ يَا ذَخِيرَةَ التَّعْبُدِينَ السَّلَامُ عَلَيْكَ يَا مِصْبَاحَ الْعَالَمِينَ السَّلَامُ عَلَيْكَ يَا سَفِينَةَ الْعِلْمِ السَّلَامُ عَلَيْكَ يَا سَكِينَةَ الْجِلْمِ السَّلَامُ عَلَيْكَ يَا مِيزَانَ الْقَصَاصِ السَّلَامُ عَلَيْكَ يَا سَفِينَةَ الْخَلَاصِ السَّلَامُ عَلَيْكَ يَا بَحْرَ النَّدَى السَّلَامُ عَلَيْكَ يَا بَدْرَ الدُّجَى السَّلَامُ عَلَيْكَ أَيُّهَا الْأَوَاهُ الْجَلِيمِ السَّلَامُ عَلَيْكَ أَيُّهَا الصَّابِرُ الْحَكِيمُ السَّلَامُ عَلَيْكَ يَا رَيْسَ الْبَكَائِينَ السَّلَامُ عَلَيْكَ يَا مِصْبَاحَ الْمُؤْمِنِينَ السَّلَامُ عَلَيْكَ يَا مَوْلَايَ يَا أَبَا مُحَمَّدٍ أَشْهَدُ أَنَّكَ حُجَّةُ اللَّهِ وَابْنُ حُجَّتِهِ وَأَبُو حُجَّتِهِ وَأَمِينُهُ وَأَبُو أَمَنَاتِهِ وَأَنَّكَ نَاصِحَتِ

Ziyarat of Imam Zayn al-'Abidin (A.S.)

فِي عِبَادَةِ رَبِّكَ وَ سَارَعْتَ فِي مَرْضَاتِهِ وَ خَيَّتَ أَغْدَاءَهُ وَ
سَرْتِ أَوْلِيَاءَهُ أَشْهَدُ أَنَّكَ قَدْ عَبَدْتَ اللَّهَ حَقَّ عِبَادَتِهِ وَ اتَّقَيْتَهُ
حَقَّ تَقَاتِهِ وَ أَطَعْتَهُ حَقَّ طَاعَتِهِ حَتَّى آتَاكَ الْيَقِينَ فَعَلَيْكَ يَا
مَوْلَايَ يَا ابْنَ رَسُولِ اللَّهِ أَفْضَلَ التَّجِيَّةِ وَالسَّلَامِ وَرَحْمَةَ اللَّهِ
وَبَرَكَاتِهِ.

Peace be on You, O Ornament of the worshippers, Peace be on
You, O Ornament of those who strive. Peace be on You, O leader
of the pious ones. Peace be on You, O guardian of the Muslims.
Peace be on You, O delight of the eyes of those with powers of
insight and gnostics, Peace be on You, O the descendent of the
eminent ones, Peace be on You, O the successor of the successors.
Peace be on You, O treasurer of the legacy of the Prophet, Peace be
on You, O light for those who are lonely, Peace be on You, O light
of those striving. Peace be on You, O the lamp for those who are
contented, Peace be on You, O the strength of the devout ones.
Peace be on You, O the lamp of the Universe, Peace be on You, O
ship of knowledge. Peace be on You, O the abode of patience.
Peace be on You, O the scales of accounting, Peace be on You, O
the ship through which salvation can be attained, Peace be on You,
O sea of generosity. Peace be on You, O one who is a full moon
on a dark night, Peace be on You, O one who bore difficulties with
forbearance, Peace be on You, O patient, wise one, Peace be on
You, O foremost of those who weep. Peace be on You, O the
Guiding light of the believers, Peace be on You, O my master, O
Abu Muhammad I bear witness that you are proof of God, son of
His proof and the father of His proofs and His representatives, I

bear witness that you are the father of His proofs and representatives and that you urged the worship of your Lord and that you hastened to please Him and you disappointed His enemies and pleased His true slaves. I bear witness that you worshipped Allah the true way He should be worshipped and you fulfilled your duties to Him the way it should be fulfilled, you obeyed Him the way He should be obeyed until death overtook you. O my master, the son of the Prophet I send the best greetings and salutations. May the mercy and blessings of Allah be on you

زِيَارَةُ الْإِمَامِ مُحَمَّدِ بْنِ عَلِيٍّ الْبَاقِرِ (ع)

بِسْمِ اللَّهِ الرَّحْمَنِ الرَّحِيمِ

السَّلَامُ عَلَيْكَ أَيُّهَا الْبَاقِرُ يَعْلَمُ اللَّهُ السَّلَامُ عَلَيْكَ أَيُّهَا
 الْفَاحِصُ عَنْ دِينِ اللَّهِ السَّلَامُ عَلَيْكَ أَيُّهَا الْمَيِّتُ لِحُكْمِ اللَّهِ
 السَّلَامُ عَلَيْكَ أَيُّهَا الْقَائِمُ بِقِسْطِ اللَّهِ السَّلَامُ عَلَيْكَ أَيُّهَا
 النَّاصِحُ لِعِبَادِ اللَّهِ السَّلَامُ عَلَيْكَ أَيُّهَا الدَّاعِي إِلَى اللَّهِ السَّلَامُ
 عَلَيْكَ أَيُّهَا الدَّلِيلُ عَلَى اللَّهِ السَّلَامُ عَلَيْكَ أَيُّهَا الْحَبْلُ الْمُنِينُ
 السَّلَامُ عَلَيْكَ أَيُّهَا الْفَضْلُ الْمُبِينُ السَّلَامُ عَلَيْكَ أَيُّهَا النُّورُ
 السَّاطِعُ السَّلَامُ عَلَيْكَ أَيُّهَا الْبَدْرُ الْأَمِيعُ السَّلَامُ عَلَيْكَ أَيُّهَا
 الْحَقُّ الْأَبْلَجُ السَّلَامُ عَلَيْكَ أَيُّهَا السَّرَّاجُ الْأَسْرَجُ السَّلَامُ
 عَلَيْكَ أَيُّهَا النَّجْمُ الْأَزْهَرُ السَّلَامُ عَلَيْكَ أَيُّهَا الْكَوْكَبُ الْأَبْهَرُ
 السَّلَامُ عَلَيْكَ أَيُّهَا الْمَنزَّةُ عَنِ الْمَعْضِلَاتِ السَّلَامُ عَلَيْكَ أَيُّهَا
 الْمَعْصُومُ مِنَ الزَّلَّاتِ السَّلَامُ عَلَيْكَ أَيُّهَا الزُّكِّيُّ فِي الْحَسَبِ
 السَّلَامُ عَلَيْكَ أَيُّهَا الرَّفِيعُ فِي النَّسَبِ السَّلَامُ عَلَيْكَ أَيُّهَا
 الْقَصْرُ الْمَشِيدُ السَّلَامُ عَلَيْكَ يَا حُجَّةَ اللَّهِ عَلَى خَلْقِهِ أَجْمَعِينَ
 أَشْهَدُ يَا مَوْلَايَ أَنْكَ قَدْ صَدَقْتَ بِالْحَقِّ صَدَقَاً وَبَقَرْتِ
 الْعِلْمَ بَقْرًا وَنَثَرْتَهُ نَثْرًا لَمْ تَأْخُذْكَ فِي اللَّهِ لَوْمَةٌ لِاتِمٍّ وَكُنْتَ

لِلدِّينِ غَيْرِ مُكَاتِمٍ وَقَضَيْتَ مَا كَانَ عَلَيْكَ وَأَخْرَجْتَ
 أَوْلِيَاءَكَ مِنْ وِلَايَةِ غَيْرِ اللَّهِ إِلَى وِلَايَةِ اللَّهِ وَأَمَرْتَ بِطَاعَةِ اللَّهِ
 وَنَهَيْتَ عَنِ مَعْصِيَةِ اللَّهِ حَتَّى قَبَضَكَ اللَّهُ إِلَى رِضْوَانِهِ وَ
 ذَهَبَ بِكَ إِلَى دَارِ كَرَامَتِهِ وَإِلَى مَسَاكِينِ أَصْفِيَانِهِ وَ مُجَاوِرَةِ
 أَوْلِيَائِهِ السَّلَامُ عَلَيْكَ وَرَحْمَةُ اللَّهِ وَبَرَكَاتُهُ.

Ziyarat of Imam Muhammad b. 'Ali al-Baqir (A.S.)

Peace be on You, O one who split open knowledge, Peace be on You, O one who searched for God's path, Peace be on You, O one who clarified the laws of Allah, Peace be on You, O one who was upright in upholding God's justice, Peace be on You, O one who advised the slaves of Allah, Peace be on You, O one who invited others towards Allah, Peace be on You, O one who guided to Allah, Peace be on You, O strong rope of Allah, Peace be on You, O manifest grace of Allah, Peace be on You, O brilliant light, Peace be on You, O radiant moon, Peace be on You, O clear truth, Peace be on You, O light of lights, Peace be on You, O radiant star, Peace be on You, O most glittering planet, Peace be on You, O one untouched by wrongdoing, Peace be on You, O one who was preserved from errors, Peace be on You, O pure one of noble descent, Peace be on You, O one of exalted lineage, Peace be on You, O lofty palace, Peace be on You, O proof of Allah over all His creatures. I bear witness, O my master, that you came out openly with the truth, and that you split open knowledge completely, and you spread it properly, you were not touched by the ignoble ones, you did not hide the religion and you fulfilled your duties, and you brought forth your friends from the allegiance of other than Allah towards Allah. You commanded the obedience of Allah and forbade the sinning against Allah until Allah took you to Himself and took you to the abode of His nobility and to the

resting place of His chosen ones and the proximity of His friends. Peace
be on You, and may the mercy and blessings of Allah be on you.

زِيَارَةُ الْإِمَامِ جَعْفَرِ بْنِ مُحَمَّدٍ الصَّادِقِ (ع)

بِسْمِ اللَّهِ الرَّحْمَنِ الرَّحِيمِ

السَّلَامُ عَلَيْكَ أَيُّهَا الْإِمَامُ الصَّادِقُ السَّلَامُ عَلَيْكَ أَيُّهَا
الْوَصِيُّ النَّاطِقُ السَّلَامُ عَلَيْكَ أَيُّهَا الْفَاتِحُ الرَّابِعُ السَّلَامُ
عَلَيْكَ أَيُّهَا السَّنَامُ الْأَعْظَمُ السَّلَامُ عَلَيْكَ أَيُّهَا الصِّرَاطُ الْأَقْرَمُ
السَّلَامُ عَلَيْكَ يَا مَصْبَاحَ الظُّلُمَاتِ السَّلَامُ عَلَيْكَ يَا رَافِعَ
المُغْضِيَاتِ السَّلَامُ عَلَيْكَ يَا مُفْتَاخَ الْخَيْرَاتِ السَّلَامُ عَلَيْكَ يَا
مَعْدِنَ الْبَرَكَاتِ السَّلَامُ عَلَيْكَ يَا صَاحِبَ الْحُجَّجِ وَالدَّلَالَاتِ
السَّلَامُ عَلَيْكَ يَا صَاحِبَ الْبَرَاهِينِ الْوَاضِحَاتِ السَّلَامُ عَلَيْكَ
يَا نَاصِرَ دِينِ اللَّهِ السَّلَامُ عَلَيْكَ يَا نَافِرَ حُكْمِ اللَّهِ السَّلَامُ
عَلَيْكَ يَا فَاصِلَ الْخِطَابَاتِ السَّلَامُ عَلَيْكَ يَا كَافِيَ الْكُرْبَاتِ
السَّلَامُ عَلَيْكَ يَا عَمِيدَ الصَّادِقِينَ السَّلَامُ عَلَيْكَ يَا لِسَانَ
النَّاطِقِينَ السَّلَامُ عَلَيْكَ يَا خَلْفَ الْخَائِفِينَ السَّلَامُ عَلَيْكَ يَا
رَعِيمَ الصَّادِقِينَ الصَّالِحِينَ السَّلَامُ عَلَيْكَ يَا سَيِّدَ الْمُسْلِمِينَ
السَّلَامُ عَلَيْكَ يَا كَهْفَ الْمُؤْمِنِينَ السَّلَامُ عَلَيْكَ يَا هَادِيَ
الْمُضِلِّينَ السَّلَامُ عَلَيْكَ يَا سَاكِنَ الطَّائِعِينَ السَّلَامُ عَلَيْكَ يَا
مَوْلَايَ إِنَّكَ عَلَّمَ الْهُدَى وَالعُرْوَةَ الْوُثْقَى وَشَمْسُ الصُّحَى

وَبِحْرُ النَّدَى وَكَهْفِ الْوَرَى وَالْمَلِّ الْأَعْلَى صَلَّى اللَّهُ عَلَى
رُوحِكَ وَبَدَيْكَ السَّلَامَ عَلَيْكَ وَعَلَى الْعَبَّاسِ عَمَّ رَسُولِ
اللَّهِ وَرَحْمَةً اللَّهُ وَبَرَكَاتُهُ.

Ziyarat of Imam Ja'far b. Muhammad al-Sadiq (A.S.)

Peace be on You, O truthful Imam, Peace be on You, O successor
of the speaking (Qur'an), Peace be on You, O pure, eminent one,
Peace be on You, O one at the greatest zenith. Peace be on You, O
the most upright path, Peace be on You, O the light of those in
darkness, Peace be on You, O bearer of difficulties, Peace be on
You, O the key of virtue, Peace be on You, O the source of
blessings, Peace be on You, O one with the proofs [of God] and
guides, Peace be on You, O the one with clear proofs, Peace be on
You, O the helper of the religion of God, Peace be on You, O the
disseminator of the laws of God, Peace be on You, O most decisive
preacher, Peace be on you, O the remover of difficulties. Peace be
on You, O the pillar of the truthful ones, Peace be on You, O the
tongue of those who are the speaking Qur'an, Peace be on You, O the
descendant of those who feared Allah, Peace be on You, O the
leader of the truthful and upright ones, Peace be on You, O leader
of the Muslims, Peace be on You, O the refuge of believers, Peace
be on You, O guide of those gone astray, Peace be on You, O
abode of the obedient ones, Peace be on You, O my master you are
the standard of guidance, the firm rope of Allah and the morning
sun, the sea of generosity, the refuge place of the pious and the
supreme model. May Allah bless your body and soul, Peace be on

You and on al-'Abbas, the uncle of the Prophet of God, may the
mercy and blessings of Allah be upon you.

زِيَارَةُ بَنَاتِ رَسُولِ اللَّهِ (ص)

بِسْمِ اللَّهِ الرَّحْمَنِ الرَّحِيمِ

السَّلَامُ عَلَيْكَ يَا رَسُولَ رَبِّ الْعَالَمِينَ السَّلَامُ عَلَيْكَ يَا
صَفْوَةَ جَمِيعِ الْأَنْبِيَاءِ وَالْمُرْسَلِينَ السَّلَامُ عَلَيْكَ يَا مَنْ اخْتَارَهُ
اللَّهُ عَلَى الْخَلْقِ أَجْمَعِينَ وَرَحْمَةً اللَّهُ وَيُورِكَاتُهُ السَّلَامُ عَلَى
بَنَاتِ السَّيِّدِ الْمُصْطَفَى السَّلَامُ عَلَى بَنَاتِ النَّبِيِّ الْمُجْتَسَى
السَّلَامُ عَلَى بَنَاتِ مَنْ اصْطَفَاهُ اللَّهُ فِي السَّمَاءِ وَفَضَّلَهُ عَلَى
جَمِيعِ الْبَرِيَّةِ وَالْوَرَى السَّلَامُ عَلَى ذُرِّيَةِ السَّيِّدِ الْجَلِيلِ مِنْ
نَسْلِ إِسْمَاعِيلَ وَسَلَالَةِ إِبْرَاهِيمَ الْخَلِيلِ السَّلَامُ عَلَى بَنَاتِ
النَّبِيِّ الرَّسُولِ السَّلَامُ عَلَى أَخَوَاتِ فَاطِمَةَ الزُّهْرَاءِ الْبَتُولِ
السَّلَامُ عَلَى الذُّرِّيَّةِ الطَّيِّبَةِ الطَّاهِرَةِ وَالْعِتْرَةِ الزَّوَكِيَّةِ الزَّاهِرَةِ
بَنَاتِ خَاتَمِ النَّبِيِّينَ وَسَيِّدِ الْأَنْبِيَاءِ وَالْمُرْسَلِينَ وَخَيْرَةِ رُسُلِ اللَّهِ
أَجْمَعِينَ السَّلَامُ عَلَى الذُّرِّيَّةِ الطَّاهِرَةِ الزَّوَكِيَّةِ وَالْعِتْرَةِ
الْمُصْطَفَوِيَّةِ السَّلَامُ عَلَى زَيْنَبَ وَأُمَّ كُلثُومَ وَرُقَيْيَةَ السَّلَامُ عَلَى
الشَّرِيفَاتِ الْأَخْسَابِ وَالطَّاهِرَاتِ الْأَنْسَابِ السَّلَامُ عَلَى
بَنَاتِ الْأَبَاءِ الْأَعْظَمِ وَسَلَالَةِ الْأَجْدَادِ الْأَكْبَارِ الْأَفْخَامِ
عَبْدِ الْمُطَلِّبِ وَعَبْدِ مَنْفَى وَهَاشِمِ وَرَحْمَةُ اللَّهِ وَيُورِكَاتُهُ.

Ziyarat of the daughters of the Prophet of God (S.A.W.)

Peace be on you, O Messenger of the Lord of the Universe, Peace be on you, O choicest of all the Prophets sent, Peace be on you, O one whom Allah chose over all creatures, may His mercy and blessings be upon you. Peace be on the daughters of the chosen leader. Peace be on the daughters of the chosen Prophet, Peace be on the daughters of one whom Allah has selected in the heavens and has raised him over all creatures and pious ones; Peace be on the progeny of eminent leader from the progeny of Isma'il and descendants of Ibrahim, the friend of Allah, Peace be on the daughters of the Prophet, the Messenger, Peace be on the sisters of Fatima al-Zahra, the chaste one, Peace be on the virtuous, pure progeny and the chaste, radiant family, daughters of the seal of the Prophets and the daughters of the leaders of the Prophets and Messengers and the choicest of all the Prophets of Allah, Peace be on the pure virtuous progeny and the family of the chosen one; Peace be on Zaynab, Umm Kulthum and Ruqayya, Peace be on the honorable ones of noble descent, pure lineage. Peace be on the daughters of the great ancestors and the lineage of noble and eminent ancestry 'Abd al-Mutallib, and 'Abd al-Manaf and Hashim, may the mercy and blessings of Allah be on you all.

زِيَارَةُ أُمَّ النَّبِيِّ فَاطِمَةَ

وَالِدَةَ أَبِي الْفَضْلِ الْعَبَّاسِ (ع)

بِسْمِ اللَّهِ الرَّحْمَنِ الرَّحِيمِ

السَّلَامُ عَلَيْكَ يَا زَوْجَةَ وَلِيِّ اللَّهِ السَّلَامُ عَلَيْكَ يَا زَوْجَةَ
أَمِيرِ الْمُؤْمِنِينَ السَّلَامُ عَلَيْكَ يَا أُمَّ النَّبِيِّ السَّلَامُ عَلَيْكَ يَا أُمَّ
الْعَبَّاسِ بْنِ أَمِيرِ الْمُؤْمِنِينَ عَلِيِّ بْنِ أَبِي طَالِبٍ رَضِيَ اللَّهُ تَعَالَى
عَنْكَ وَجَعَلَ الْجَنَّةَ مَنْزِلَكَ وَمَأْوَاكَ وَرَحْمَةً اللَّهُ وَبَرَكَاتُهُ.

Ziyarat of Umm al-Banin, the mother of Abu'l Fadhl al-'Abbas

Peace be on You, O wife of the friend of God, Peace be on You, O
the wife of the Commander of the faithful, Peace be on You, O
Umm al-Banin. Peace be on You, O the mother of al-'Abbas, the
son of the Commander of the faithful, 'Ali b. Abu Talib, May Allah
be pleased with you, may He make heaven as your permanent
abode and resting place, May Allah's mercy and blessings be upon
you

Chapter 4. Pilgrimage Sites in Mecca

4.1. Maps of Holy Kaaba and Mecca Mosque

Sketch of the Ka'bah and Sections Related to the Hājjī

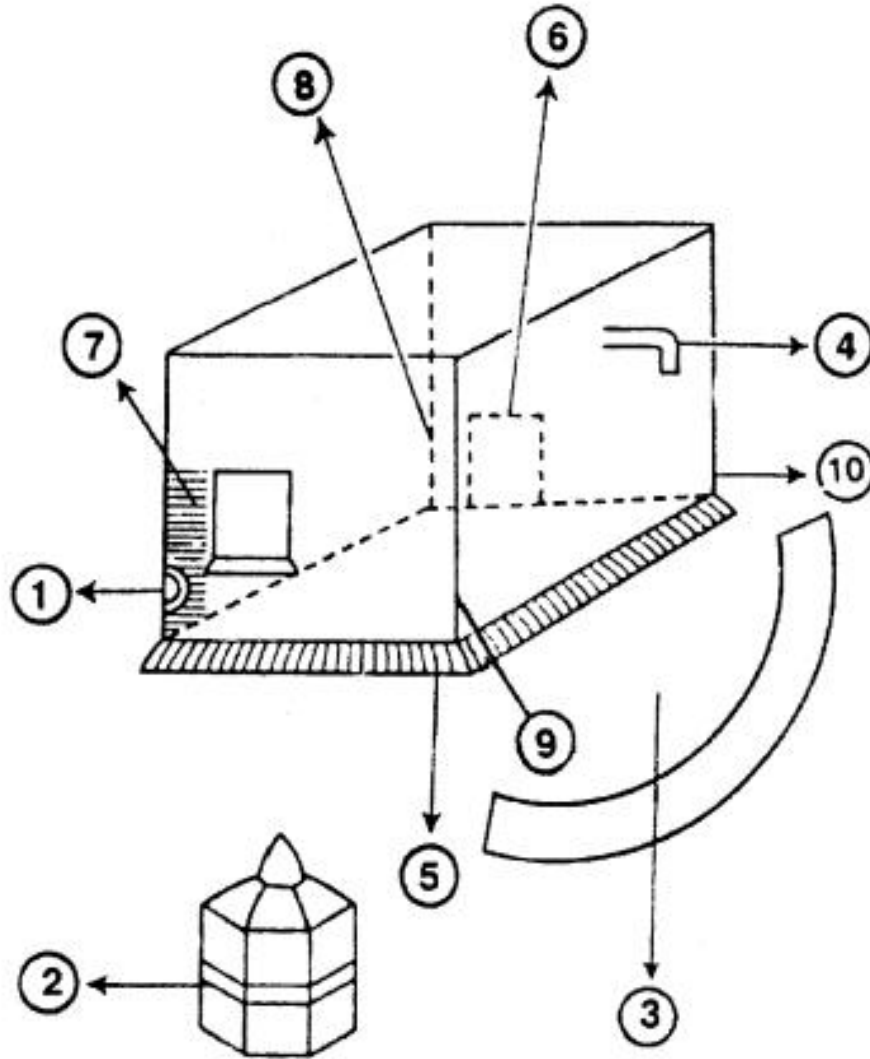

[1] Ḥajar al-Aswad	[6] Mustajar
[2] Maqām Ibrāhīm	[7] Hatwim
[3] Ḥijr Ismā'il	[8] Al-Ruknīl Aimānī
[4] Mizāb al-Raḥmah	[9] Al-Ruknīl Irāqī
[5] Shadharwan	[10] Al-Ruknīl Shāmī

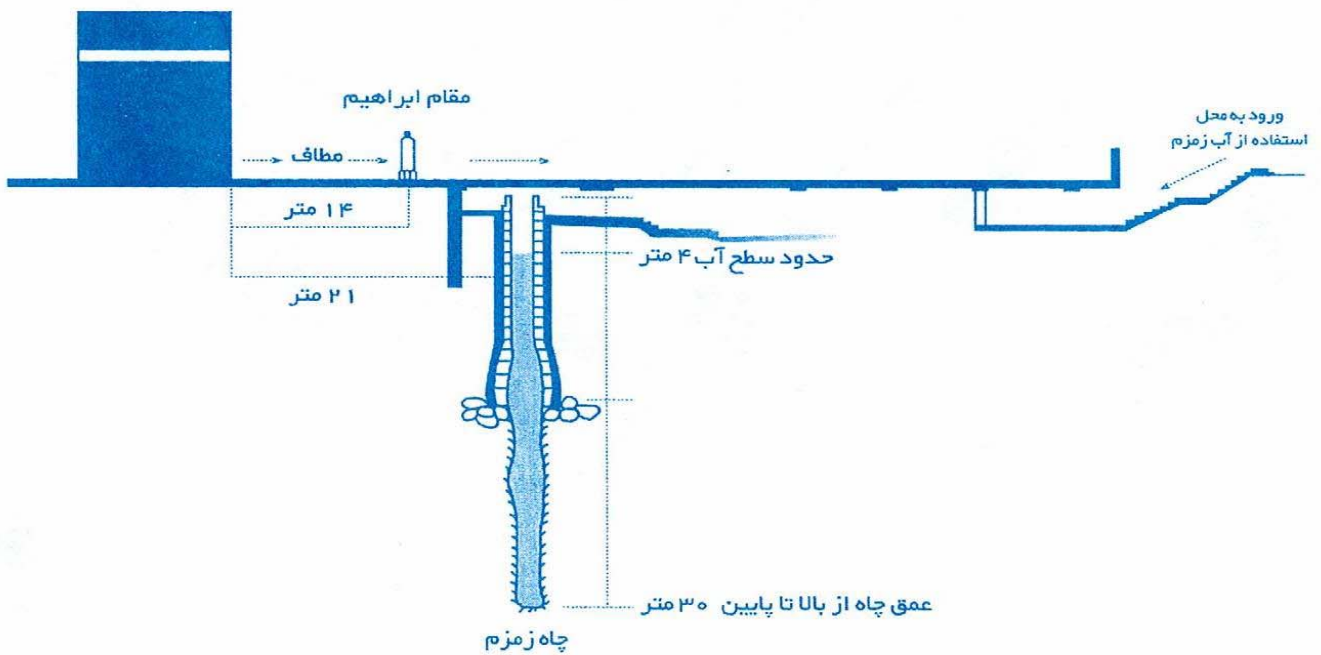
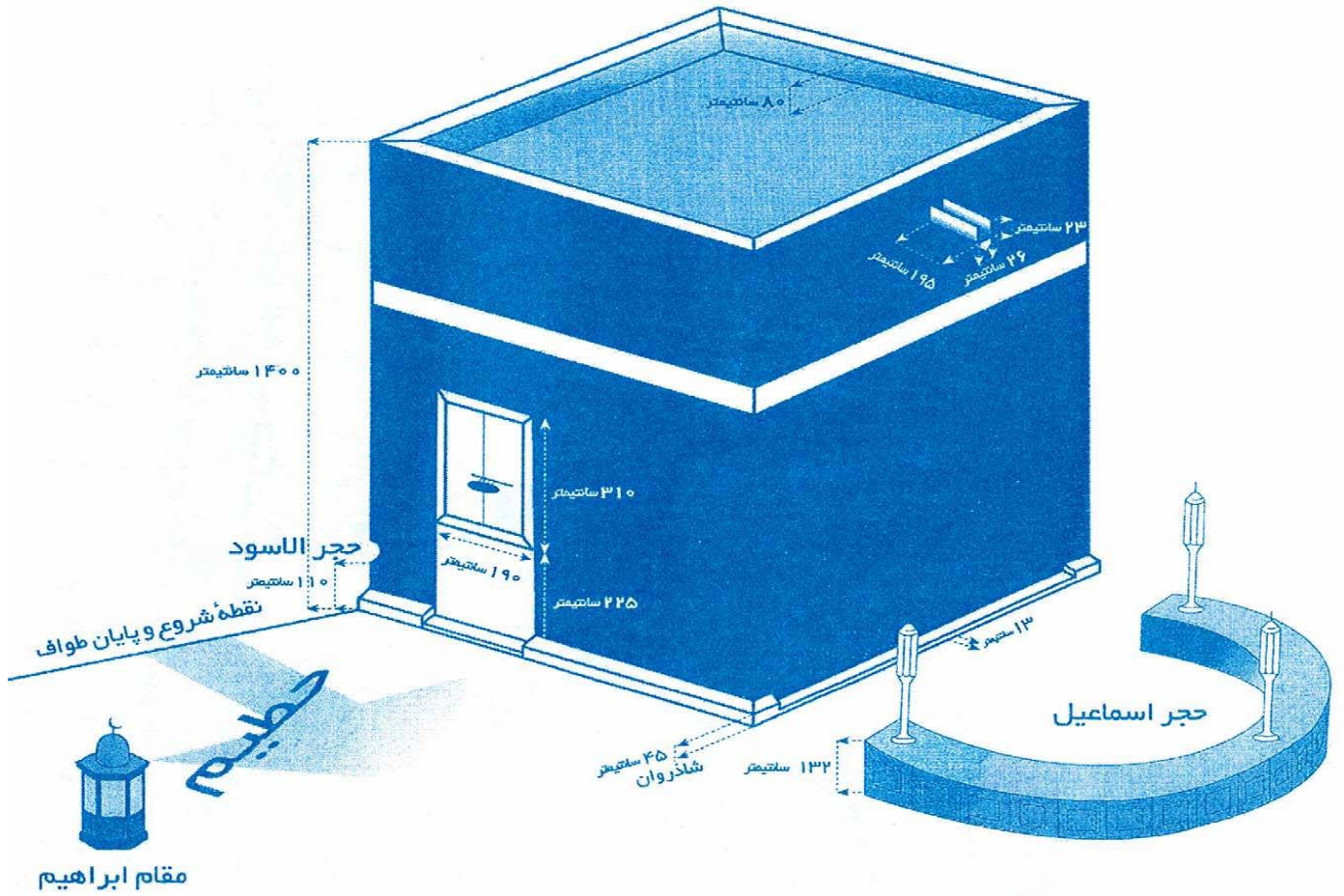

Map of Masjid-al-Haram, Mecca

So turn your face towards Masjid al-Haram (Sacred Mosque),
and (O Muslims) wherever you may be, turn your faces (when
you pray) towards it. ... Holy Quran, Al-Baqara 144

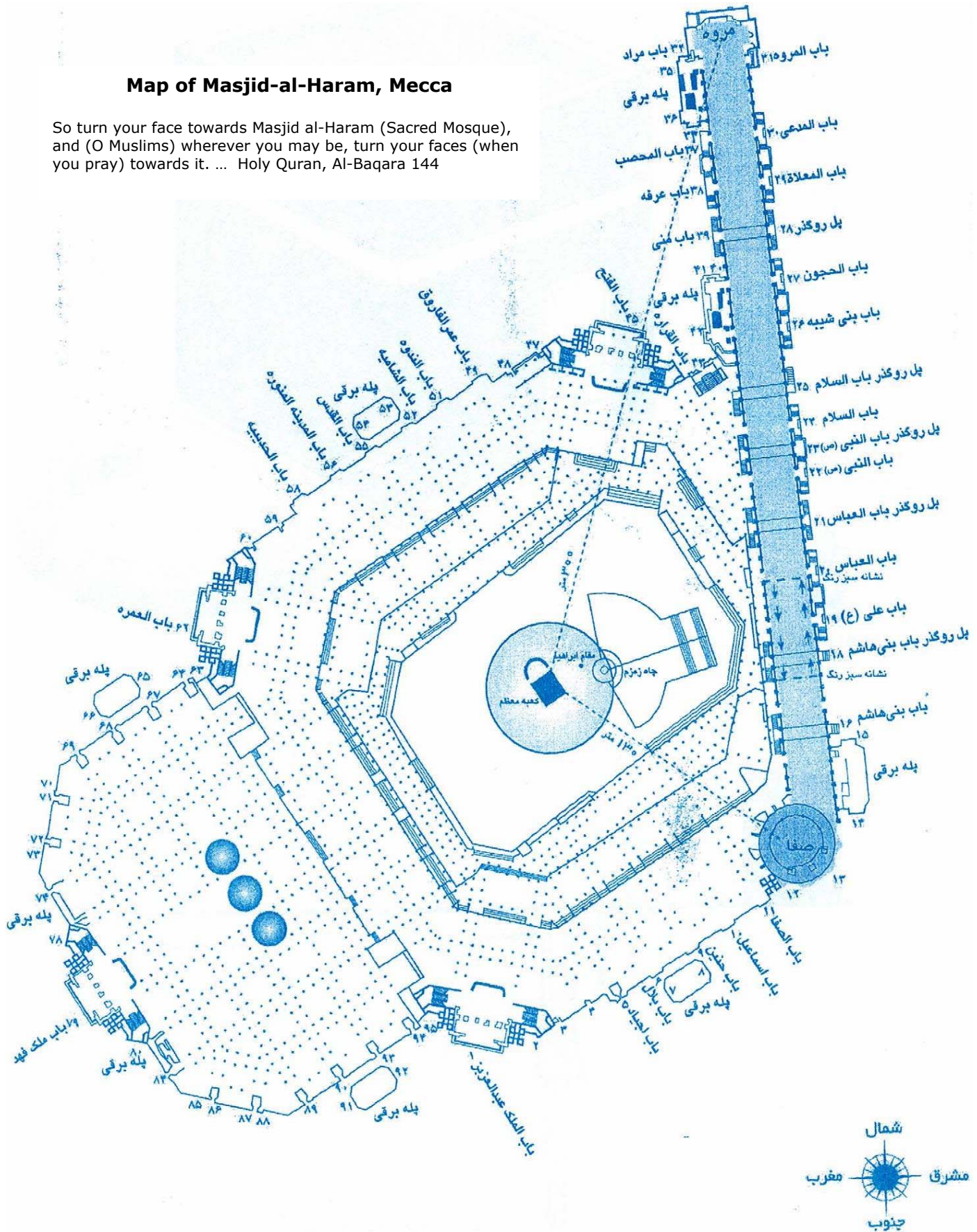



Map of Masjid-al-Haram and Immediate Sorroundings, Mecca

4.2. Ziyara'ats in and around Mecca

4.2.1. Kaaba

The Kaaba is the black stone building that stands majestically in the center of Masjid-ul-Haraam. It's foundations were first laid out by Prophet Adam (a) and is exactly located under the Baitul al-Mamoor which is in Jannat. The strong waves and currents during the time of the flood of Prophet Nuh (a) destroyed the Kaaba but its foundation remained.

Prophet Ibrahim (a) later built the walls of the Kaaba anew. During the time of the Prophet Muhammad (p) most Arabs were idol worshippers and had placed their gods all around at a high elevation in the Kaaba.

First Imam, Ali bin Abu Talib (a) was born inside the Holy Kaaba, one can still notice the crack in the wall which opened up to allow Bibi Fatemah binte Asad (a) to enter a few days before the birth of Imam Ali (a).



View of Holy Kaaba
Makaam-e-Ibrahim, door of Kaaba, Hajr-e-Isma'il, Meza'ab al-Rahmat are visible

4.2.2. Hajr-e-Ismail

Also called wall of Hateem is the curved wall that is situated on the North-Western side of the Kaaba. This wall is about five feet high and it stretches out towards Bab al-Fateh (one of the gates of Masjid-ul-Hara'am on the North-Western side) in a semi circle. The wall has openings on both Western and Eastern sides and ends short of the Kaaba without touching it (see figure).

The enclosure within the wall contains the Holy graves of Prophet Ismail (a), Bibi Hajra (a) and many other 80 other Prophets (a) according to Ahadiths. It is highly recommended (Mustahib) to recite two rakaat Salaat inside the walled enclosure. This is the place where you should ask for your Haajat.

The famous golden water drainage pipe called Meza'ab al-Rahmat is also located on the North-Western side of the Kaaba. It drains rain water into the walled enclosure of Hajr-e-Ismail.

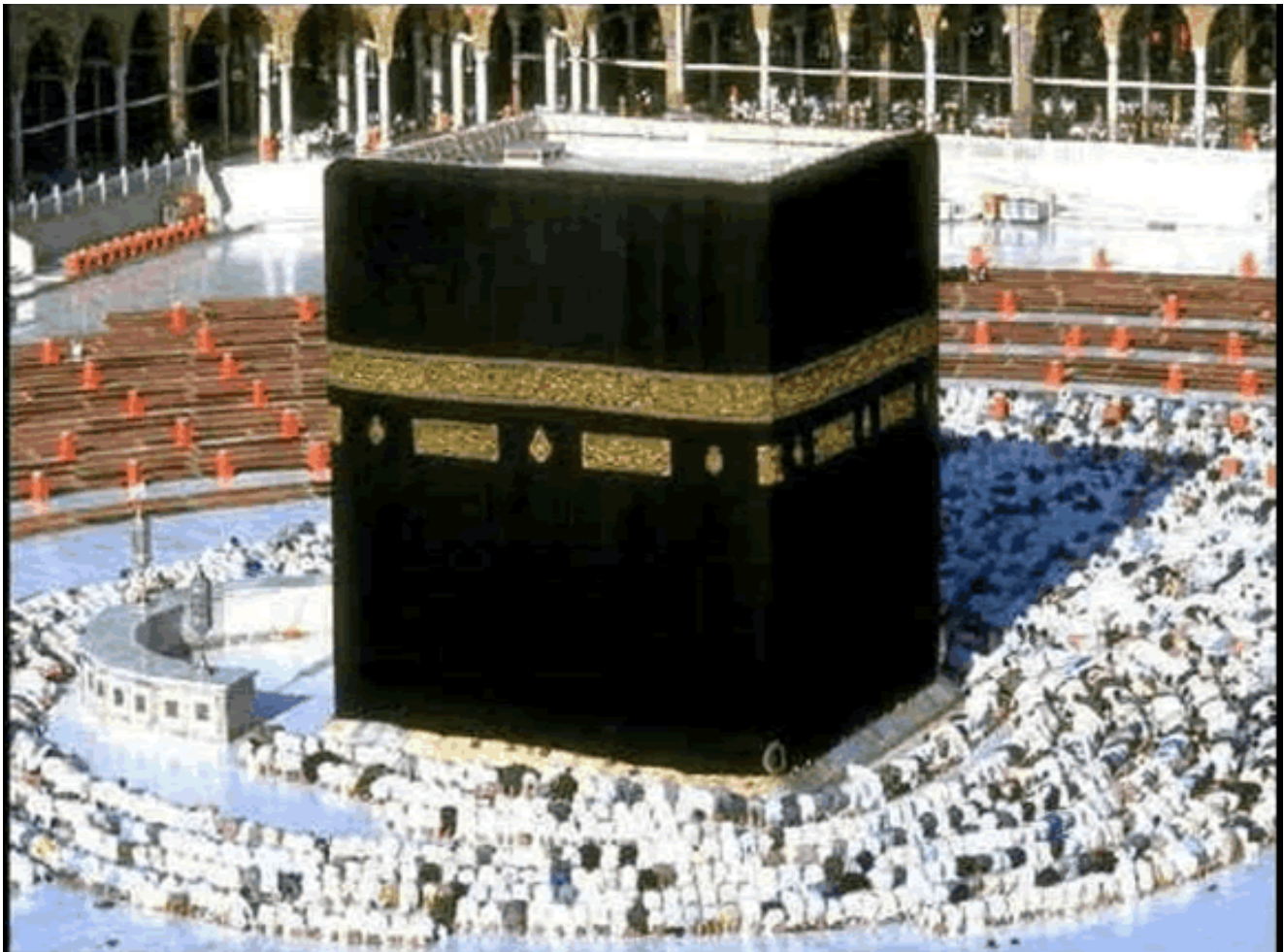

Hajr-e-Ismail is the semicircular wall on the left

4.2.3. Hajr-ul-Aswad

Is the famous Black Stone from Heaven situated in the South-Eastern corner of the Kaaba. It is narrated that Prophet Adam (a), while in Heaven, used to sit and pray on this stone. When Prophet Adam (a) descended to earth as a vice-regent (Khalifa at-Allah (SWT)) this stone started crying, as it missed the company of Hazrat Adam (a), so Allah (SWT) sent this stone to the earth and the angels put it in the Kaaba. On the Day of Judgment it will bear witness for those who have traveled for Hajj and Umrah.



4.2.4. Makaam-e-Ibrahim

This is the glass enclosure containing a block of stone with the footprints of Prophet Ibrahim (a) carved up in it. It is situated on the eastern side of the Kaaba about 13 meters from the door of the Kaaba. The footprints of Prophet Ibrahim (a) were stamped in a block of stone while he was building the Kaaba.



4.2.5. Zam Zam

Is the famous fountain of drinking water situated about 50 meters from the South-Eastern corner of the Kaaba or opposite the Black Stone (Hajr-ul-Aswad). The fountain has been replaced by a water pumping and storage station that supplies drinking water to almost all of Arabia.

As per the story in the Quran Prophet Ibrahim (a), commanded by Allah (SWT), left his wife Hajra (a) and his son Ismail (a) near the Kaaba to spread His word. Hazrat Ismail (a), an infant at that time, became thirsty so Bibi Hajra went to look for water. She went running seven times between the Hills of Safa and Marwa but could not find water.

While Bibi Hajra (a) was desperately searching for water, Hazrat Ismail (a) rubbed his feet on the ground due to thirst and due to the miracle of Allah (SWT) a water fountain sprang furiously near his feet.

Upon her return Bibi Hajra (a) saw a fountain of drinking water flowing at the feet of Ismail (a). To stop the water from flowing into the sand she started building small mud dams around it and called up "ZAM-ZAM" meaning stop-stop (from flowing away). Hence the name of the fountain is ZAM-ZAM. It is said that the water level has not decreased and remained the same as centuries ago. It is pure and natural spring water good for drinking and free from any kind of sediments, parasites or germs.

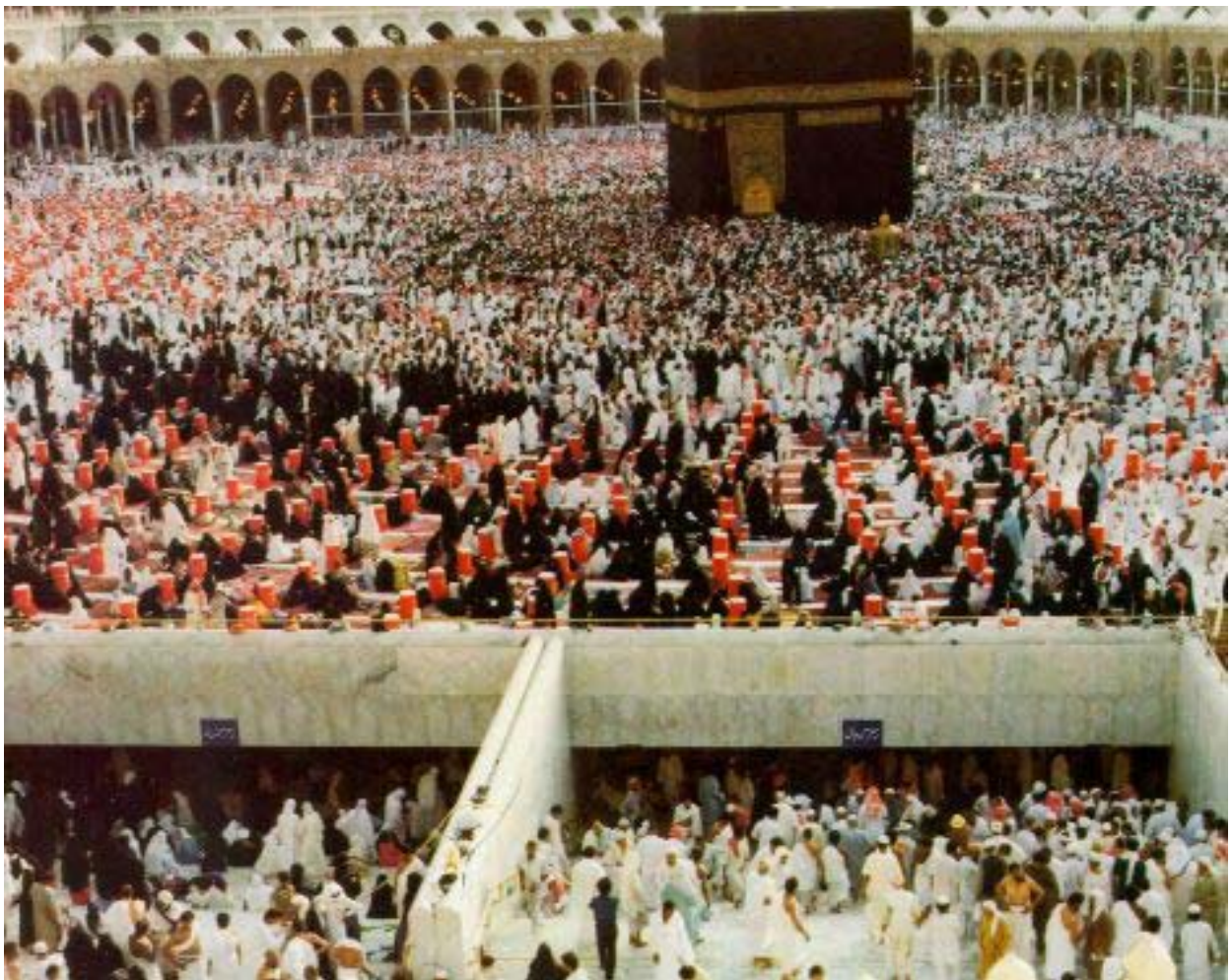

View of the Kaaba from the entrance to Zam Zam fountain

4.2.6. Hills of Safa and Marwa

These are the two mounds situated on the eastern side of the Kaaba. The mound of Marwa is on the North-Eastern side and mound of Safa is on the south-eastern side of the Kaaba. Bibi Hajra (a) made seven circuits between these two mounds to look for water for Hazrat Ismail (a). Allah Almighty (SWT) loved that act of hers so much that He made it obligatory on all Hajjis, performing Hajj or Umrah, to walk/run between these two mounds.



People praying on mound Safa

4.2.7. Jannat al-Mualla

This is a cemetery in Mecca that existed from before the time of the Prophet of Islam (a). Many relatives of the Prophet Muhammad (p) are buried over here. A few well known personalities from among them are:

4.2.7.1. Bibi Khadijatul Kubra (a)

She was a rich, prosperous and successful businesswoman who entrusted the Prophet (p) of Allah (SWT) with her trade caravans to Syria, Egypt, Yemen and other places; she was later married to the Prophet (p). She is buried in Janatul-Mualla.

4.2.7.2. Abu Talib bin Abdul Mutalib (a)

He was the father of our first Imam, Ali-Ibne-Abi-Talib (a). Through out his life he raised, protected, and served the Prophet of Islam (p). While he was alive the Prophet (p) preached Islam in Mecca and the rest of Arabia without any hindrance and fear. As soon as he passed away the Prophet (p) had to migrate from Mecca to Medina. The Prophet (p) of Allah (SWST) was 50 years old at the time when Hazrat-e-Abu Talib passed away. He is buried in Janatul-Mualla.

4.2.7.3. Abdul Mutalib (a)

He was the paternal grandfather of the Prophet (p). He is buried in Janatul-Mualla.

4.2.7.4. Hazrat Abdullah bin Abdul Mutalib (a)

He is the father of our Prophet (p). It is narrated that when Masjid-e-Nabawee in Medina was being extended, his grave was dug and his body which is intact, was transferred to Jannat-ul-Maulla. He is buried in Janatul-Mualla.

4.2.7.5. Hazrat Amina Bint-e-Wahab

She is the mother of our Prophet (p) who passed away when the Prophet (p) was about 5 years old. Some historians say that she is buried at Jannatul-Mualla and some say she is buried at a place called Abawa.



A view of the cemetery of Jannat al-Mualla in Mecca

4.2.8. Masjid-e-Jinn

A group of Jinn were passing by, when they heard the Prophet of Allah (a) reciting the Holy Quran. They were so moved that they came to the Prophet, repented and accepted Islam. A Masjid was later built at that place. It is called Masjid-e-Jinn.

4.2.9. Cave of Thawr

This cave is situated on the mountain of Jabal Thawr. During the Hijrah (migration to Medina from Mecca) the Holy Prophet (p) stayed here for three days. The miraculous incident of a spider's web and a pigeon laying eggs occurred at the mouth of this cave. This misled the pagan Arab trackers, who came in search of the Prophet (p), and thus the Prophet of Allah (p) was saved from them.

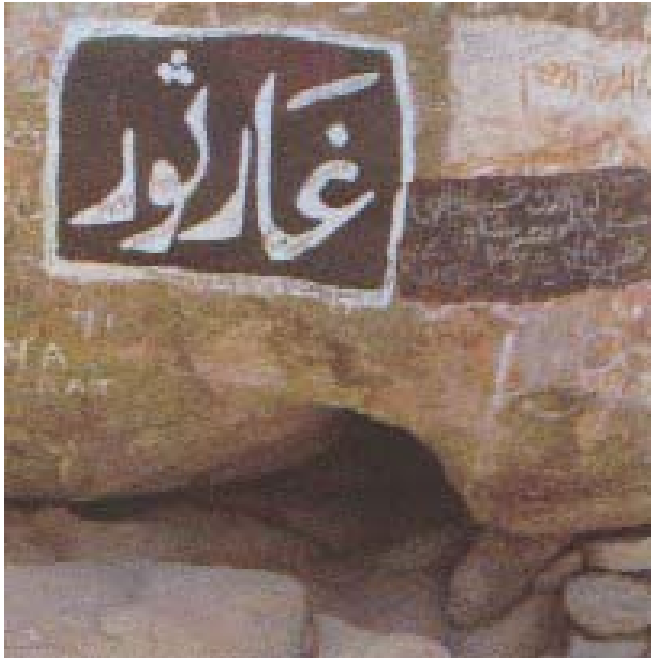

Cave of Thawr

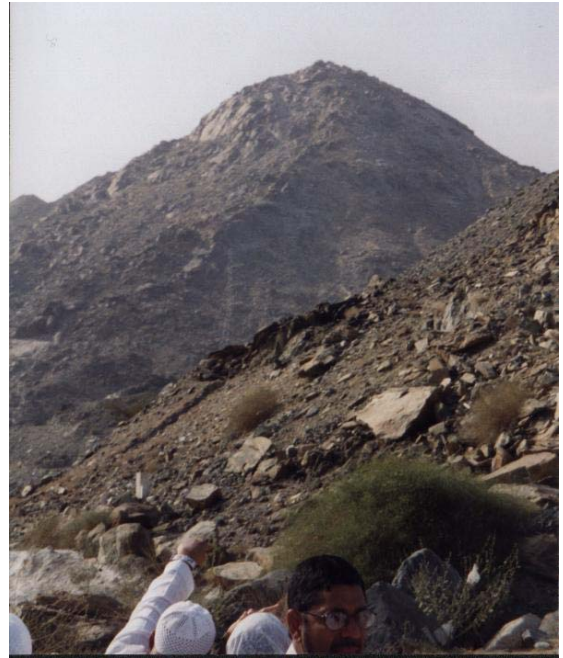

Jabal al-Thawr

4.2.10. Cave of Hira

This cave is situated just outside of Mecca at an elevation of about a couple of thousand feet on the mountain of "Jabal al-Nour". The first 'revelation' of "Iqra Bismi Rabbek" was revealed here. The Prophet (p) along with Hazrat-e-Khatejah (a) and Imam Ali (a) ibne Abi Talib (a) used to travel and stay there for days at a time to pray to Allah (SWT) in relative safety and comfort.



Cave of Hira on Mount Jabal al-Nour
The cave faces the Kaaba in city of Mecca seen on top right side



Arafah

Also known as the 'tent' city that comes into existence only one day in a year on the 9th of Dulhijja when all Hajjis are required to stay here from Dhohar until Maghrib. It is said that this is the first place where Prophet Adam (a) and Bibi Havva (a) met for the first time after they were asked to leave Jannat. It is situated about 14 KM outside of Mecca.

4.2.11. Jabal-e-Rahmah

This mountain is in Arafah. During Hajj or Umra one may climb it to pray two rakaat Salaat of Haajat. Allah (SWT) accepted hazrat-e-Adam's (a) dua and supplication while he prayed at this mountain that resulted in his meeting with Bibi Havva (a).



Views of Arafah and mount Jabal-e-Rahmah

4.2.12. Muzdhalifa or Ma'shar

This is a plain or valley situated between Arafah and Minna outside of Mecca. The Hajjis are required to spend the night here and collect 70 pebbles for hitting the Shaitaan in Minna.



4.2.13. Mina

This is a valley situated outside of Mecca. It too is a tent city that comes to life for three to five days in a year. All Hujjaj are required to spend two or four nights in Minna to hit (Rami) the three Shaitaans and sacrifice an animal. Men must also do Taqseer or Halaq there. Women are only required to do Taqseer (not Halaq).

4.2.14. Masjid-e-Kheef in Mina

This masjid is situated in Minna. It is highly recommended and a great thawab to pray 6 Rakaat Salaat in this Masjid as it is said that many Prophets (a) of Allah (SWT) prayed here.



Tents in Mina

4.3. Approximate Distances to Mina, Muzdalifah and Arafat

Masjid-ul-Haraam to Mina Boundary	3.2 Miles (5 Km)
Mina to Muzdalifah Boundary	3.4 Miles (5.5 Km)
Muzdalifah to Arafat Bounday	3.4 Miles (5.5 Km)

4.4. Maps of Mecca and Surroundings

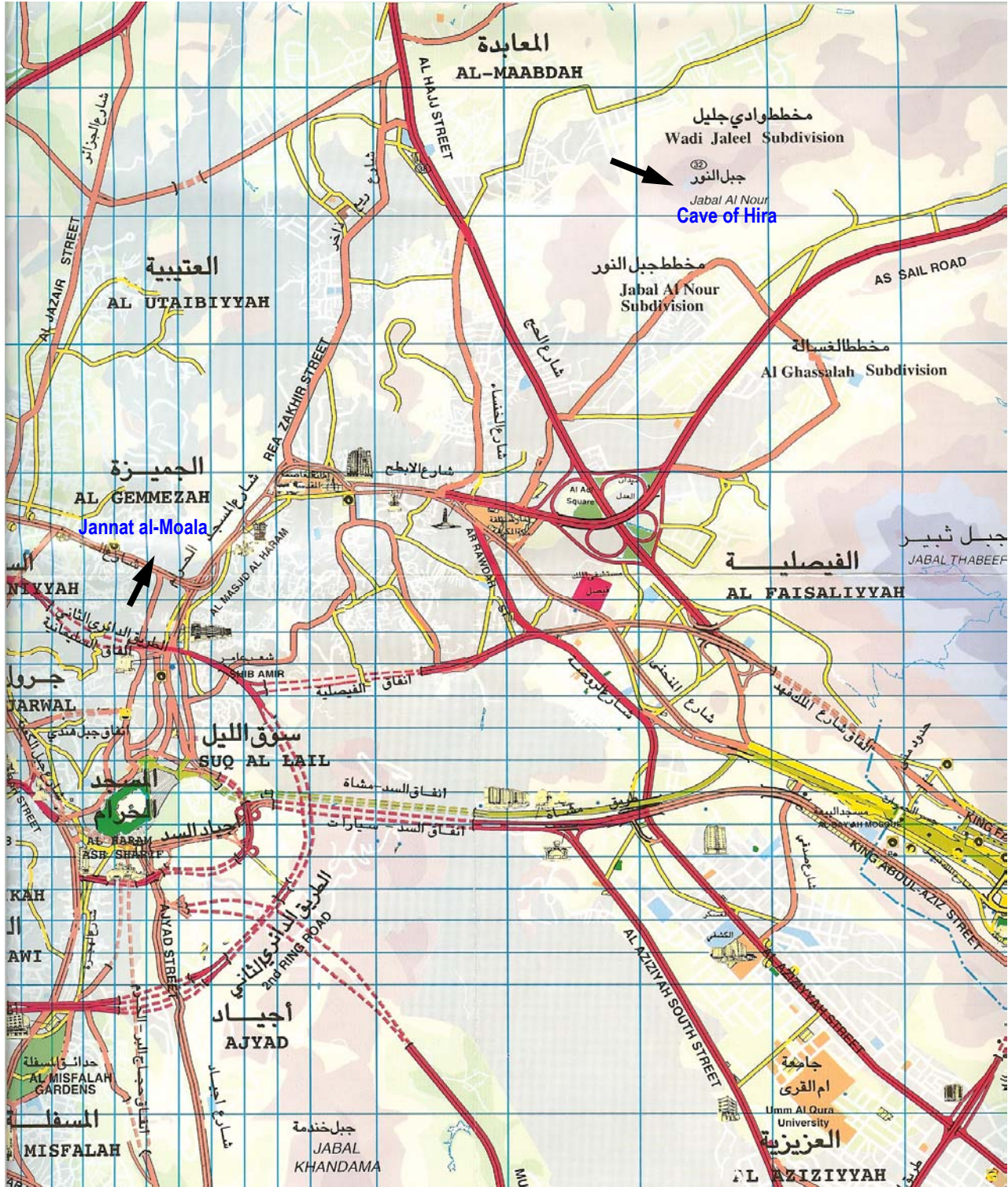

Map of Masjid-al-Haram, Jannat al-Moala and Cave of Hira, Mecca

Cemetery of Jannat al-Moala has graves of Abdul Motalib (a), Abdullah bin Abdul-Motalib (a), Bibi Amina (a), Abu Talib (a), Bibi Khadija (a) and other relatives of Prophet Muhammad (p). Prophet Muhammad stayed in Cave of Thawr during Hijrah from Mecca to Medina.



Map of Masjid-al-Haram and Cave of Thawr, Mecca

Prophet Muhammad (p) stayed in Cave of Thawr for three days while migrating from Mecca to Medina.

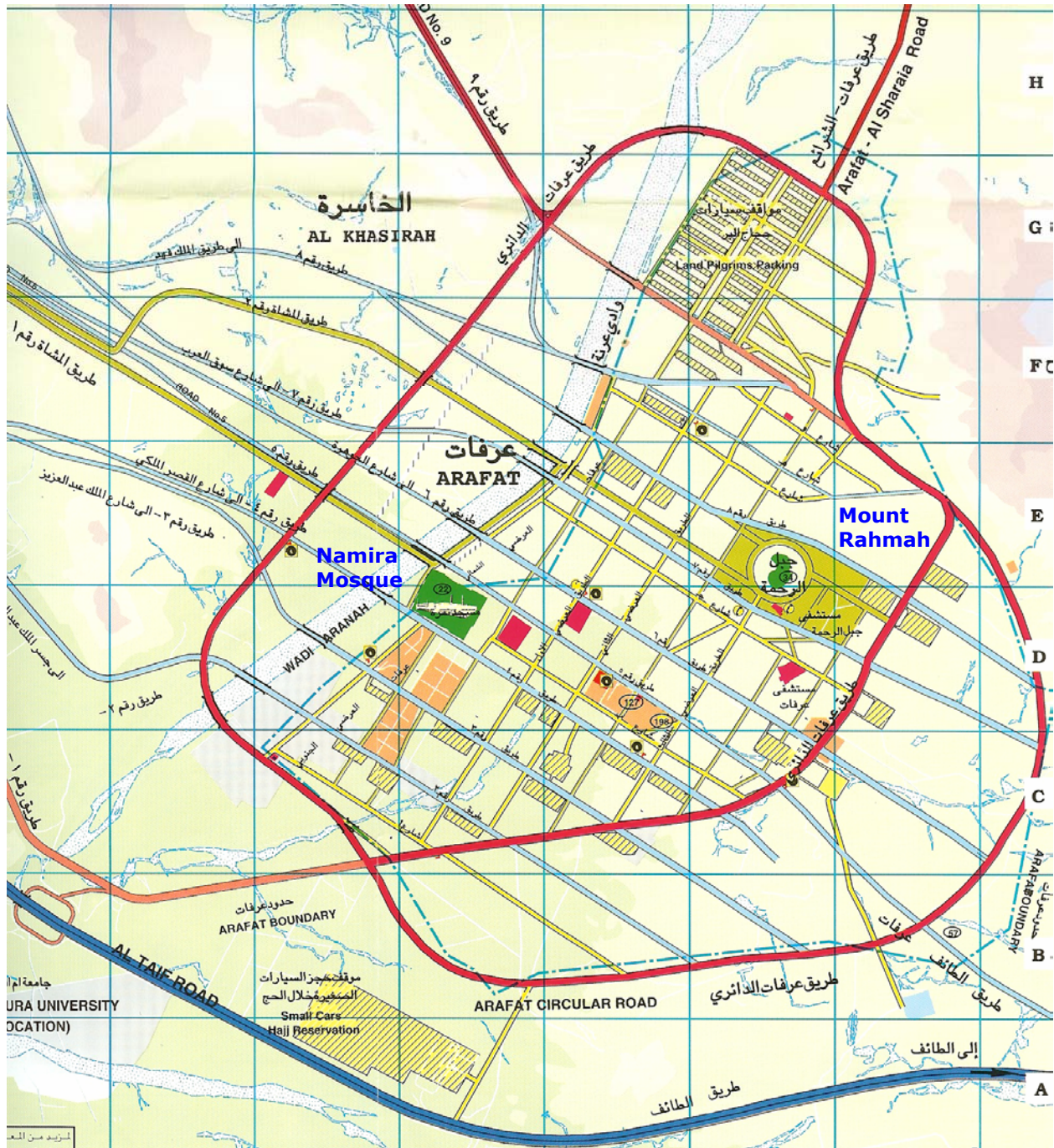

Map of Arafat

All Hajjis are required to stay in Arafat on 9th Dulhijja from Dohar till Maghrib. Jabal-e-Rahmah in Arafat is the place where Allah accepted the dua of Prophet Adam (a) and he met Bibib Havva (a) for the first time after leaving Jannat.

Important Note: Not all of Namira Mosque is inside of Arafat Boundary



Map of Mina and Muzdalifah or Mashar



Satellite Image of Holy Mecca Mosque, Mina, Muzdalifah and Arafat

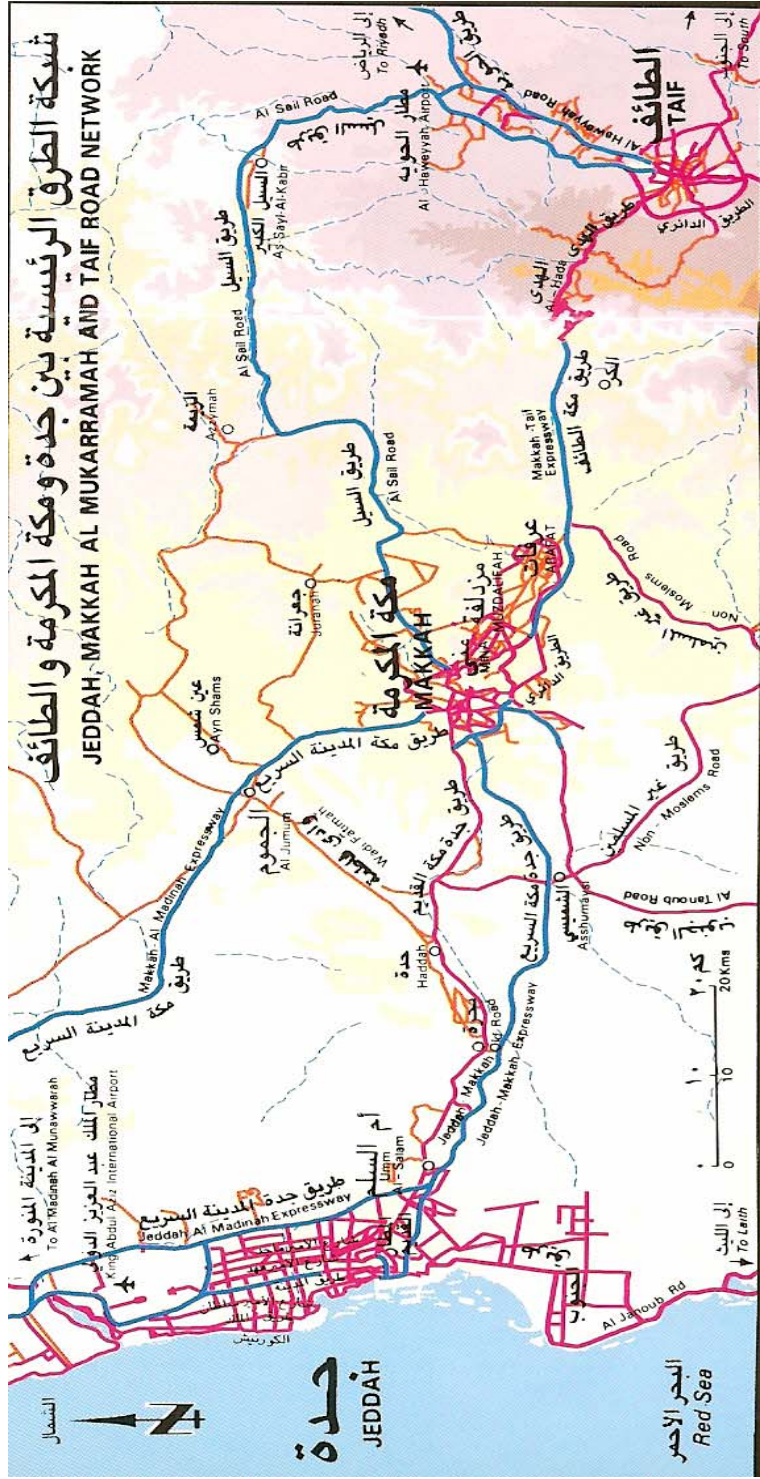

Chapter 5. Islamic Legal Rulings (Ahka'am) for Umra-e-Tomatto and Hajj-e-Tomatto

5.1. Taqlid Requirements

It is strictly recommended that you be in the Taqlid of one of the following three renowned contemporary Marja-e-Taqlid:

- Ayatullah Syed Ali Al-Hussaini Al-Sistani
- Ayatullah Syed Ali Khameni
- Ayatullah Sheikh Fazil Lankarani

5.2. Khums

You may fall in one of the following three categories in regards to Khums. Please follow the ruling regarding Khums that applies to you.

- Either, you regularly pay khums and have done so on your eligible savings. In this case you do not need to worry about Khums requirements for Hajj trip as you already have paid it.
- Or, you have not paid Khums yet or have not regularly paid Khums on all of your assets in the past. In this case you must calculate and pay the Khums before going for Hajj.
- Or, if you have never paid Khums or have not paid Khums as per the proper ruling by a Marja-e-Taqlid or do not intend to pay Khums on all of your assets (which is Hara'am). Then you must, at least, pay Khums on all of the money to be used for your hajj trip; clothing, luggage, tickets and any extra money that you may carry with you. This will decrease the chances of your Hajj being rejected.

Please check with the representative (Wakeel) of your Marja-e-Taqlid for details about how, where, when and who to pay the khums as per your Marajah's recommendations, before embarking on the Hajj pilgrimage.

5.3. Proper Qira'at

All Arabic words must be recited with proper qira'at. There are two places where we need to pronounce Arabic words correctly. These are as follows:

- At the time of reciting Talbia(Labaik), after the niyat of wearing Ihram.
- During the prayers after each Tawaf.

5.4. Types of Hajj

There are three types of obligatory Hajj: Tamatto, Ifraad and Qiraan. Hajj-e-Tamatto is for those who reside more than 48 miles from Mecca and the other two are for those who reside within 48 miles of Mecca.

5.4.1. Hajj-e-Tamatto

For people who reside more than 48 miles from Mecca.

5.4.2. Hajj-e-Ifraad

For those living in Mecca and it's surrounding.

5.4.3. Hajj-e-Qiran

Also for those living in Mecca and it's surrounding.

Only the legal rulings for Hajj-e-Tamatto will be explained in this book. For Hajj-e-Ifraad and Hajj-e-Qiran please refer to Manasik-e-Hajj books of your Marja-e-Taqlid.

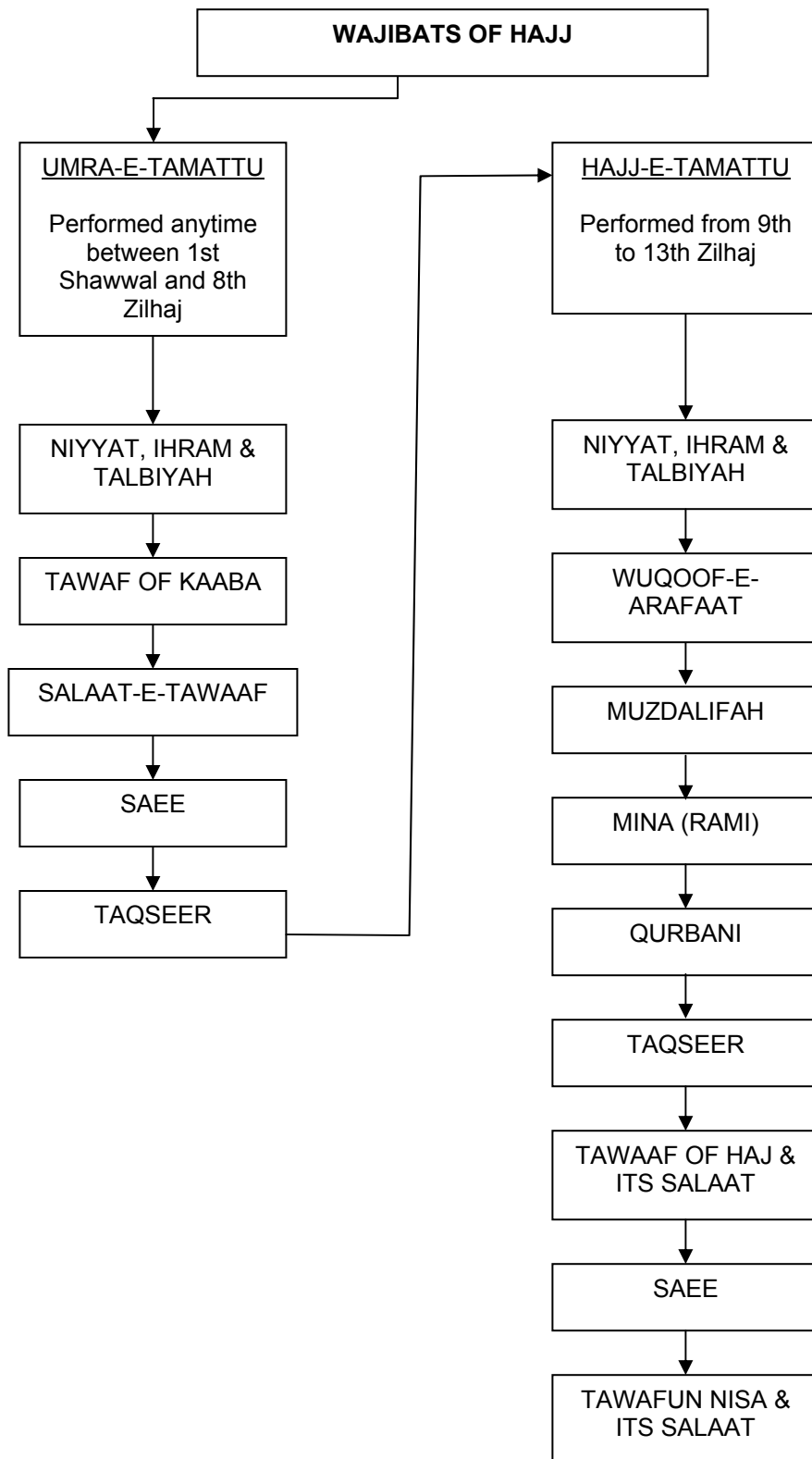

5.5. Hajj-e-Tamatto

Following are the details of Hajj-e-Tamatto, which becomes Wajib, with certain conditions, on people living outside Mecca. As Umar-e-Tamatto is required to be performed before Hajj-e-Tamatto we will discuss Umar-e-Tamatto first.

5.5.1. Umra-e-Tamatto

Umra-e-Tamatto may be performed anytime from 1st of Shawaal through 8th of Dhu Al-Hijja. It consists of the following five distinct steps that must be completed:

- Wear Ihram from one of the Meeqaat (explained below) places for Hujjaj coming from outside of Saudi Arabia.
- Tawaf-e-Kaaba: completing seven circles around the Kaaba and the wall of Hateem starting from and ending at the Hajr-e-Aswad (black stone).
- Salat-e-Tawaf: Two rakkah salat recited with correct qira'at. This will also be explained by Maulana.
- Sa'ee between Safa'a and Marwa'a: Safa'a and Marwa'a are two mounds, 130 and 300 meters from the Kaaba within the main Mosque of Kaaba. Sa'ee is to make seven one-way trips between Safa'a and Marwa'a starting at Safa'a and ending at Marwa'a. Each trip is counted as going from either Safa'a to Marwa'a, or vice versa, one time (not round trip).
- Taqseer: To cut a few strands of hair from your head or clip one nail from a finger of your hand.

Note: For Umra-e-Mufradah (the optional Umra, which is not part of Hajj) you need to complete two more steps. These are: Tawaf-un-Nisa and Salat-e-Tawaf

5.5.1.1. Meeqaat

There are several Meeqat places where you put on the Ihram before entering Mecca for Hajj or Umra. Only two of these are open to the pilgrims from abroad to put on their Ihram. Details of them are as follows:

- MASJID-E-SHAJARA. This Meeqat is used by pilgrims who, after arriving in Jeddah, go to Medina. It is about 7 km from the city of Medina on the way to Mecca. Occasionally, the Saudi government may close entry into Medina from the 1st of Dul Al-hijja through the 9th to prevent crowding and over population. In that case you may proceed to Mecca via the second Meeqat as mentioned below. You may, also, have to go to Mecca from Jeddah if the group strength is less than 40 people.
- MASJID-E-JOHFA. This Meeqat is used by pilgrims who are going to Mecca, after arriving in Jeddah. It is 115 Km from Jeddah on the way to Medina. After putting on your Ihram, for Umra-e-Tamatto, at Masjid-e-Jofa you will stay in Mecca till 8th of Dul Al-Hijja. In this case your group may proceed to Medina around 16 or 17 Dul Al-Hijja after completing the Hajj-e-Tamatto.

Note: If the person is in Makkah and intends to perform Umra-e-Mufradah (non obligatory Umrah) he can wear his Ihram at Hudaibiyah, Ja'ranah or Tan'eem (Masjid-e-Meeqa'at also called Masjid-e-Aisha), it is not obligatory for him to proceed to a Meeqat and wear the Ihram there. Each additional Umra-e-Mufradah requires going back to Masjid-e-Meeqa'at (also called Masjid-e-Aisha) to put on Ihram.

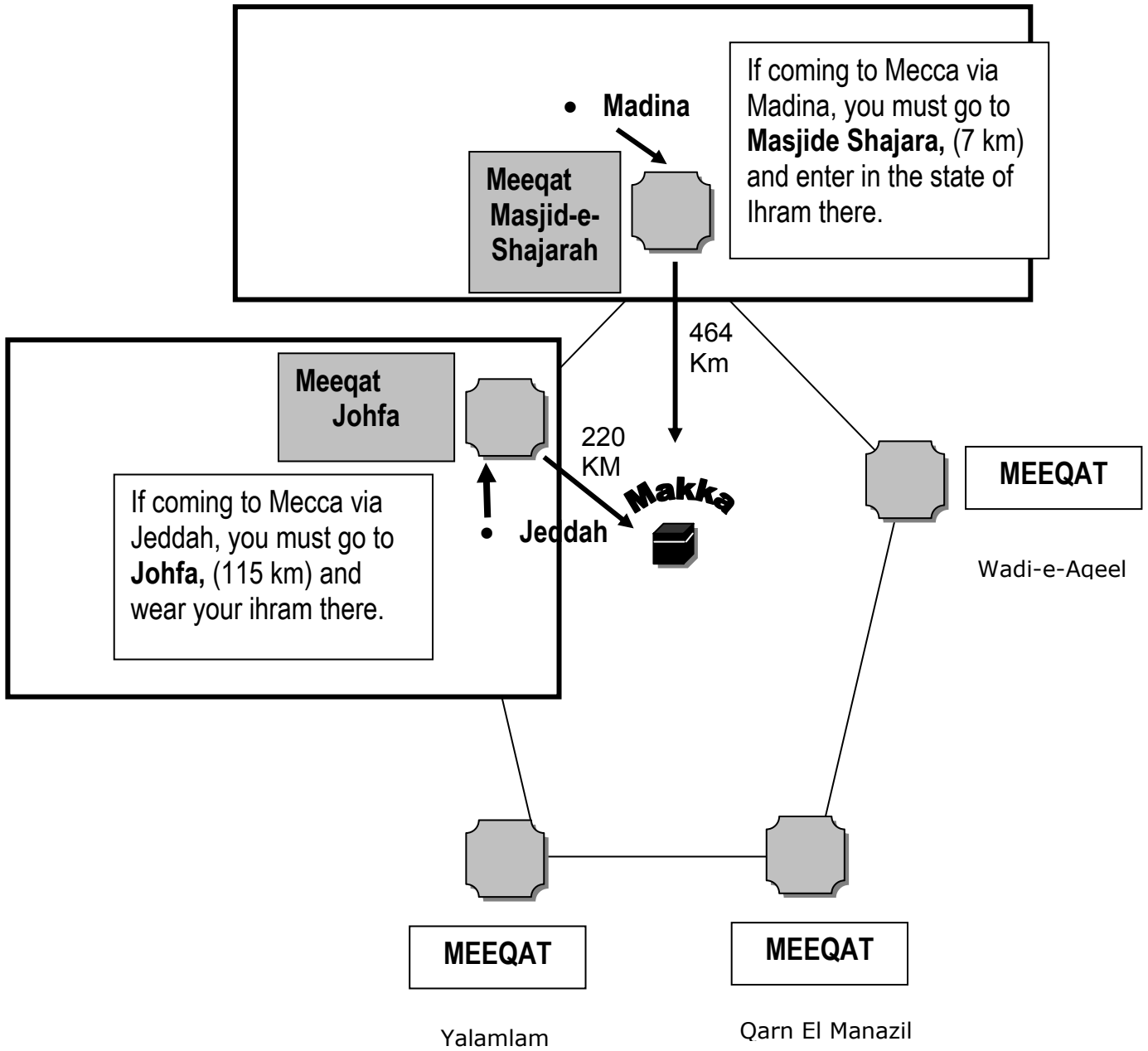

Map of Meeqats

Meeqat is the location where you put on Ihram before entering Mecca for Hajj or Umra. Only two Meeqats are open for people traveling from abroad. For Umra-e-Mufradah (optional Umra), if a person is already in Mecca , he can wear Ihram from Masjid-e-Aisha



5.5.1.2. Ihram

It is recommended (mustahab) to perform Ghushl or Wazoo before wearing an Ihram. Performing of Ghushl is highly recommended. **For Women:** During menstruation there is no restriction to perform Ghushl before wearing of Ihram. Women may wear Ihram even when their body is Najis. The only restriction is that the Ihram must be Pa'ak and not Najis.

Men should wear two pieces of unstitched clothing to get into the state of *ihram*. These are *lounge*, a piece of cloth worn around the waist downwards and the *rada*, cloak which should be worn on the shoulders. The material of these cloths should be such that if one prays while wearing them, his prayers would be correct. Therefore, they should not be made of silk and should be tahir (clean, not najis) and not stained with any impurities that render prayers null and void. In addition, the garment worn round the waist should not be made of thin and transparent cloth; it must conceal the body and not reveal it.

The two pieces of clothing which the *Muhrim* (a pilgrim in the state of ihram) should wear are exclusive to men. Women can become *Muhrim* while wearing their usual clothes whether stitched or not. For more detailed rulings on Ihram please refer to the Manasik of Hajj books of your Marja-e-Taqlid.

Note: Immediately after wearing the Ihram 25 things become hara'am (strictly forbidden) for both men and women till after Taqseer when you may wear your ordinary clothes in place of the Ihram. Of these 20 things are common for both men and women, 4 additional for men only, and one additional for women only. These will be discussed later in this chapter.

After putting on your Ihram, and before making any niyat for wearing the Ihram, perform two Raka'at Salat (mustahab) with the niyat of:

- I pray 2 Raka'at prayer for wearing Ihram of Umra-a-Tamatto for Hajjat-ul-Islam Wajib Qurbatan Elallah.

After completing the salat loosen your Ihram a little bit (like you want to wear it again) and make the niyat of wearing the Ihram as follows:

- I put on this Ihram for Umra-e-Tamatto for Hajjat-ul-Islam Wajib Qurbatan Elallah.

Note: Right after the niyat and Ihram recite Talbia as it becomes Wajib.

5.5.1.3. Talbia

It is wajib to recite Talbia all the time as much as possible after wearing the Ihram and while on your way to Mecca as follows:

لَبَّيْكَ اللَّهُمَّ لَبَّيْكَ لَبَّيْكَ لَا شَرِيكَ لَكَ لَبَّيْكَ
إِنَّ الْمَحْمُودَ وَالنِّعْمَ لَكَ وَالْمُلْكَ لَا شَرِيكَ لَكَ لَبَّيْكَ

- Labbek Allahumma Labbek, Labbek Laa Sharika Laka Labbek, Innal Hamda Wanne'mata Laka Wal Mulka, Laa Sharika Laka Labbek".

5.5.1.4. Haraam Acts after Wearing Ihram

Following are the twenty five forbidden things (Hara'am) after wearing Ihram. Please refer to the Manasik of Hajj books of your respective Marja-e-Taqleed for the penalties (Kaffarah) of each.

1. Use of products like oil, moisturizer, hand lotion, body cream, etc. on your body.
2. Use of fragrance for wearing, eating, or smelling.
3. Putting on Surma and make-up including eye make-up.
4. Looking at oneself in a mirror.
5. Cutting nails.
6. Giving or taking of blood from your body.
7. Plucking or removing hair from your body.
8. Removing a tooth.
9. Killing lice or a similar living thing that lives on the human body.
10. Use of jewelry, cosmetics and things for show off. The jewelry that you normally wear at home and is not for show off is okay. However, for women, this jewelry must not be visible to anyone including your father and husband. Any type of gold watch or ring is also forbidden for men.
11. Telling a lie, use of abusive language, and use of vulgar words.
12. Swearing.
13. Hunting.
14. Cutting grass, flowers, or a tree from near the Holy Mosque (Masjid-ul-Hara'am).

15. Carrying or keeping weapons.
16. Reciting or doing a Nikah.
17. Masturbating (Istamna).
18. Sexual intercourse.
19. Kissing for sexual satisfaction.
20. Seeing or touching anyone for sexual satisfaction.
21. For men: Covering the head is forbidden. No cap, head scarf, umbrella, cloth, towel, part of Ihram, etc.
22. For men: Wearing of stitched clothes is forbidden.
23. For men: To sit and stand under or avail a shadow or to travel in a covered vehicle (car, bus, etc.) is forbidden.

Note: As per Ayatullah Khomeini and Ayatullah Khamenai's ruling men may travel in a covered vehicle at night only but not during the day. As per Ayatullah Sistani also men may travel in a covered vehicle at night only, provided it is not raining. If it is raining outside then travel in the covered vehicle is not allowed.

24. For men: Covering the upper part of ones feet is forbidden (Hara'am) while in Ihram. No socks, shoes and slippers covering upper part of the feet are permissible.
25. For women: Covering the face is not permissible while in Ihram. It is hara'am for women to cover their face while in Ihram.

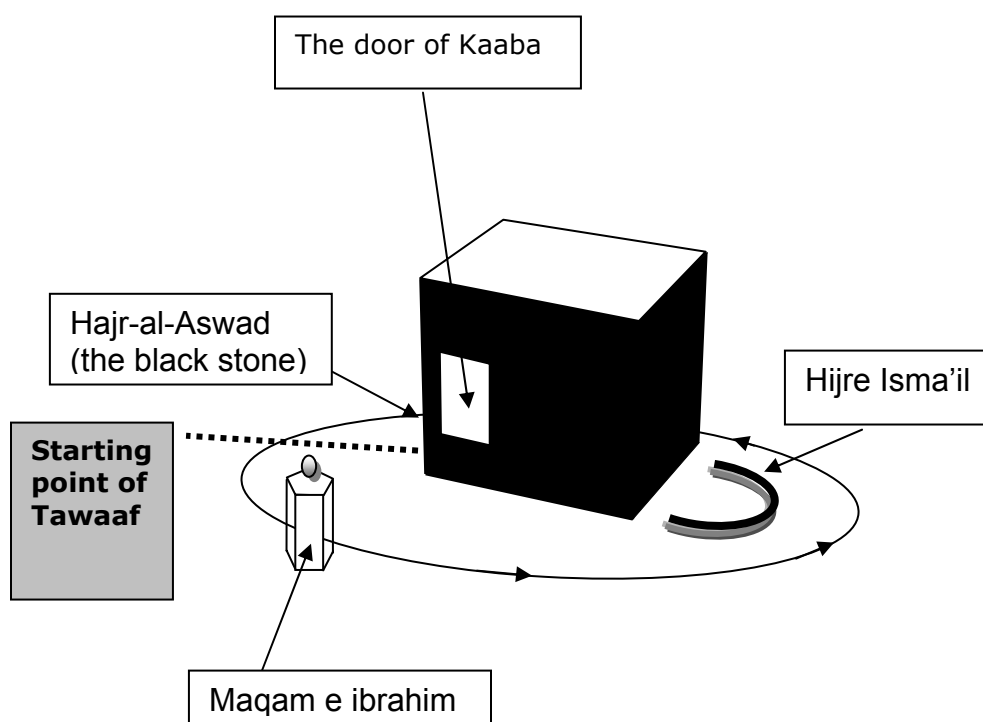

5.5.1.5. Tawaf-e-Kaaba

You may enter the Holy Mosque (Masjid-ul-Hara'am) in Mecca from any door. However, it is preferred to enter from Bab-us-Salam (gate of peace). Immediately after entering the Holy Mosque (Masjid-ul-Hara'am) pray two Raka'at (prayer) salat with the niyat of Tahiaat-e-Masjid (as a mark of respect for the Mosque). It is mustahab to pray the two Raka'at prayers. Please find a suitable place to pray so you are not obstructing the general flow of traffic.

Making seven rounds around the Holy Kaaba (beit Allah) including the wall of Hateem (also called Hajr-e-Ismail) is termed as one Tawaf-e-Kaaba. Each Tawaf begins at the Hajr-e-Aswad (or the brown colored line on the floor that extends from the Hajr-e-Aswad towards the mount of Safa'a).

You must fulfill the following conditions before and while performing Tawaf-e-Kaaba:

5.5.1.6. Obligations to be Fulfilled before Tawaf

Before starting the Tawaf make sure you have fulfilled the following five conditions:

1. Men must have had circumcision done.
2. Your body and clothes or Ihram must be Pa'ak.
3. You must be in Wazoo and/or Ghusl.
4. For men the private parts must be covered. For women the whole body must be covered except the face and palms.
5. You must make a niyat before beginning the Tawaf. The niyat of Tawaf is as follows:

➤ I perform Tawaf of Umra-e-Tamatto for Hajjat-ul-Islam Wajib Qurbatan Elallah.

5.5.1.7. Obligations to be Fulfilled during Tawaf

There are eight conditions to be fulfilled during the Tawaf:

1. You must make seven rounds around the Kaaba including the curved wall of Hateem (also called Hajr-e-Ismail) to complete one Tawaf-e-Kaaba.
2. No time gap is allowed between each of the rounds. No resting during the Tawaf is allowed. You may walk slowly and steadily around the Kaaba seven times to complete the Tawaf.
3. All seven rounds must begin at the Hajr-e-Aswad (black stone in the wall of Kaaba).
4. All seven rounds must end at Hajr-e-Aswad.
5. Your left shoulder must always and all the time be pointed towards the Kaaba. The Kaaba should always be on your left side and you must walk in a circle (orbit) around the Kaaba including the wall of Hateem (also called Hajr-e-Ismail). You may move your face left and right, however, keep your left shoulder always pointing towards the Kaaba. If for some reason you can not keep your left shoulder pointing towards the Kaaba then you must come back and re-do the same round from the place your left shoulder went out of direction to Kaaba. To do that you may walk backwards, if possible, without obstructing the general flow of traffic and start your same round from the point your left shoulder went out of direction. If you can not walk back then continue forward with rest of the people around the Kaaba including the wall of Hateem and begin the same round again from the point where your left shoulder went out of the direction to the Kaaba and so complete that round.
6. All seven rounds of a Tawaf must include wall of Hateem (also called Hajr-e-Ismail) and must be from outside that wall without touching it.
7. Tawaf should be from outside of Kaaba. You must not enter or touch the Kaaba while doing the Tawaf. You must stay about two feet away from the stone wall of the Kaaba.
8. All seven rounds of a Tawaf must be completed within the area between the wall of Kaaba and the Maqam-e-Ibrahim (containing print of feet of Hazrat-e-Ibrahim). Approximate distance between Kaaba and Maqam-e-Ibrahim is 13 Meters. The distance between Kaaba and outside wall of Hateem (Hajr-e-Ismail) is about 10 Meters. As per Ayatullah Khumeni Tawaf should be done within a 13 Meters area of the wall of Kaaba and within 3 Meters from the wall of Hateem (Hajr-e-Ismail) unless it is difficult to do the Tawaf due to crowding. As per Ayatullah Khoei and

other Maraji Tawaf may be performed from outside the described area, i.e.; 13 Meters and 3 Meters.

Note: If your Wazoo or Ghusl is discontinued during the Tawaf, and you have already completed 4 rounds or are in your fourth round, then go out to make a fresh Wazoo and continue the Tawaf from the point you went out of Wazoo and complete the Tawaf by doing the remaining 4 rounds. If your Wazoo is discontinued before completing 3 rounds of a Tawaf then make a fresh Wazoo and re-start the Tawaf from the beginning and perform all seven rounds to complete the Tawaf.

5.5.1.8. Salat-e-Tawaf

Pray two Raka'at Salat after Tawaf behind Maqam-e-Ibrahim. It is Wajib to pray two Raka'at Salat-e-Tawaf behind Maqam-e-Ibrahim facing the Kaaba. When praying make sure the Kaaba and Maqam-e-Ibrahim is in front of you and you can see both when you look towards the Kaaba. The two Raka'at prayer is like the Fajr prayer except for the Niyat which is as follows:

- I pray 2 Raka'at Salat of Tawaf-Kaaba for Umra-e-Tamatto for Hajjat-ul-Islam Wajib Qurbatan Elallah.

Please remember that Sajdah is not allowed on a carpet. Sajdah on a marble floor is okay and permissible.

5.5.1.9. Sa'ee

Completing seven rounds between mount Safa'a and mount Marwa'a, beginning at mount Safa'a is called Sa'ee. You must perform the following Niyat before starting the Sa'ee:

- I perform Sa'ee making seven rounds in between Safa'a and Marwa'a of Umra-e-Tamatto for Hajjat-ul-Islam Wajib Qurbatan Elallah.

Start the Sa'ee from mount Safa'a and walk to mount Marwa'a once. This completes one round. Running between the green lights is Mustahib in all seven rounds of a Sa'ee. Returning from mount Marwa'a to mount Safa'a completes the second round. Complete all seven rounds such that the ending point of Sa'ee is at the mount of Marwa'a. Resting, standing, or sitting in between or at the mounts of Safa'a and Marwa'a is allowed. You may continue and complete the Sa'ee if your Wazoo or Ghusl discontinues during the Sa'ee. You must begin the Sa'ee with a Wazoo, however, it is not required to have the Wazoo, until the end of the Sa'ee. So if your Wazoo discontinues during the Sa'ee it is okay to just complete the rounds.

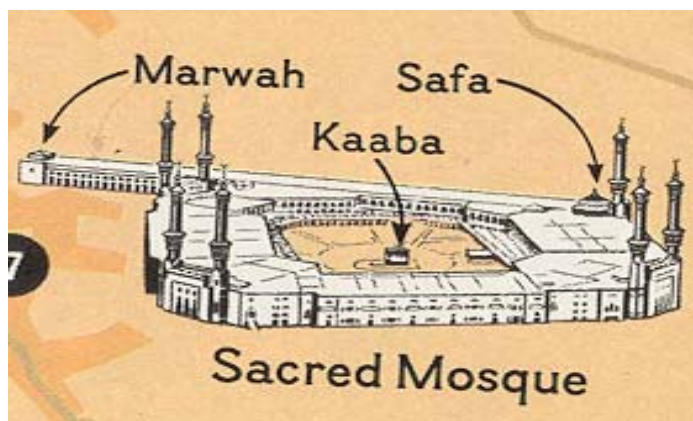

5.5.1.10. Taqseer

Taqseer means to cut some hair from your head, beard or moustache or to cut a nail after completing all seven rounds of a Sa'ee. You must perform a Niyat before doing the Taqseer as follows:

- I perform Taqseer to remove the Ihram of Umra-e-Tamatto for Hajjat-ul-Islam Wajib Qurbatan Elallah.

It is a must (Wajib) to do Taqseer after the Sa'ee. Taqseer could be performed by you or by someone who has already completed the Sa'ee and the Taqseer. Women can do Taqseer by themselves or can get it done by another woman. It is not necessary to do the Taqseer at the mount of Marwa'a or immediately after completing the Sa'ee. You may do the Taqseer after a while or on any other day. However in this case all 25 things, discussed earlier, will remain Hara'am for you and you can not remove your Ihram till after you have done the Taqseer.

5.5.1.11. Four Things Remain Hara'am after Taqseer of Umra-e-Tamatto

The following four things remain forbidden (Hara'am) after you complete the Taqseer and the Umra-e-Tamatto.

1. Cutting, pulling or destroying leaves, flowers, grass or trees from the surrounding area of Holy Haram.
2. Leaving Mecca before 8th of Dul Al-Hijja.
3. Performing Umra-e-Mufradah (an optional Umra, which is not part of Hajj).
4. Shaving your head.

<u>UMRA-E-MUFRADAH</u>	<u>UMRA-E-TAMATTU</u>	<u>HAJJ-E-TAMATTU</u>
Ihram	Ihram	Ihram
Tawaaf	Tawaaf	Arafat
Salaat-e-Tawaaf	Salaat-e-Tawaaf	Muzdalifah
Sa'ee	Sa'ee	Mina
Taqseer	Taqseer	Qurbani
Tawaafun-Nisa		Rami of Jamarah
Salaat-e-Tawaaf		Taqseer
		Tawaaf
		Salaat-e-Tawaaf
		Sa'ee
		Tawaafun-Nisa
		Salaat-e-Tawaaf

Table 1: Umra-e-Mufradah, Umra-e-Tamattu & Hajj-e-Tamattu Similarities & Differences

5.5.2. Hajj-e-Tamatto

Starting on the 8th of Dul Al-Hijja you will begin the Hajj-e-Tamatto which consists of a total of the following 14 Wajib items. Later in this book these items have been explained in details.

1. Wear Ihram for Hajj-e-Tamatto from Mecca.
2. Talbia recitation after wearing Ihram.
3. Stay in Arafat on 9th Dul Al-Hijja from Zuhr prayer until sunset.
4. Stay in Muzdalifa'a (also called Mashar-ul-Hara'am) on 10th of Dul Al-Hijja from Fajr till sunrise.
5. Rami the big Shaita'an on 10th of Dul Al-Hijja in between sunrise and sunset.
6. Sacrifice an animal on 10th after Rami at big Shaita'an.
7. Halq or Taqseer.
8. Stay in Mina for the night of 11th and 12th of Dul Al-Hijja.
9. Rami all three Shaita'an on 11th and 12th of Dul Al-Hijja.
10. Tawaf-e-Kaaba for Haj-e-Tamatto.
11. Salat-e-Tawaf for Haj-e-Tamatto.
12. Sa'ee between mount Safa'a and mount Marwa'a.
13. Tawaf-un-Nisa.
14. Salat-e-Tawaf-un-Nisa.

Note:

If you perform the above mentioned items 10 through 14 during your stay in Mina make sure you return to Mina before the mandatory and compulsory staying time in Mina. As per Ayatullah Khomeini staying at least the first half of the night in Mina is Wajib. As per Ayatullah Khoei, staying either first or the second half of the night is Wajib. (First half is from sunset to midnight and second half is from midnight to sunrise)

5.5.2.1. Wear Ihram for Hajj-e-Tamatto on 8th Dul Al-Hijja

On the 8th of Dul Al-Hijja you will proceed to Kaaba and wear your Ihram from inside the Holy Haram. It is mustahib, and not Wajib, to wear and make Niyat of Ihram from inside the Kaaba. You may wear your Ihram from your hotel, then go to the Rukn-e-Yamani side of the Kaaba, redo your Ihram, and make Niyat for wearing of Ihram as follows:

- I wear Ihram of Hajj-e-Tamatto for Hajjat-ul-Islam Wajib Qurbatan Elallah.

5.5.2.2. Haraam Acts after Wearing Ihram

Following are the twenty five forbidden things (Hara'am) after wearing Ihram. Please refer to the Manasik of Hajj books of your respective Marja-e-Taqlaed for the penalties (Kaffarah) of each.

1. Use of products like oil, moisturizer, hand lotion, body cream, etc. on your body.
2. Use of fragrance for wearing, eating, or smelling.
3. Putting on Surma and make-up including eye make-up.
4. Looking at oneself in a mirror.
5. Cutting nails.
6. Giving or taking of blood from your body.
7. Plucking or removing hair from your body.
8. Removing a tooth.
9. Killing lice or a similar living thing that lives on the human body.
10. Using jewelry, cosmetics and things for show off. The jewelry that you normally wear at home and is not for show off is okay. However, for women, this jewelry must not be

visible to anyone including your father and husband. Any type of gold watch or ring is also forbidden for men.

11. Telling a lie, use of abusive language, and use of vulgar words.
12. Swearing.
13. Hunting.
14. Cutting grass, flowers, or a tree from near the Holy Mosque (Masjid-ul-Hara'am).
15. Carrying or keeping weapons.
16. Reciting or doing a Nikah.
17. Doing of Istamna.
18. Sexual intercourse.
19. Kissing for sexual satisfaction.
20. Seeing or touching anyone for sexual satisfaction.
21. For men: Covering the head is forbidden. No cap, head scarf, umbrella, cloth, towel, part of Ihram, etc.
22. For men: Wearing of stitched clothes is forbidden.
23. For men: To sit and stand under or avail a shadow or to travel in a covered vehicle (car, bus, etc.) is forbidden.

Note: As per Ayatullah Khomeini and Ayatullah Khamenai's ruling men may travel in a covered vehicle at night only but not during the day. As per Ayatullah Sistani also men may travel in a covered vehicle at night only, provided it is not raining. If it is raining outside then travel in the covered vehicle is not allowed.

24. For men: Covering the upper part of ones feet is forbidden (Hara'am) while in Ihram. No socks, shoes and slippers covering upper part of the feet are permissible.
25. For women: Covering the face is not permissible while in Ihram. It is hara'am for women to cover their face while in Ihram.

Note: Right after the niyat and Ihram you must recite Talbia (it is Wajib).

5.5.2.3. Talbia

It is wajib to recite Talbia all the time as much as possible after wearing the Ihram and while on your way to Mecca as follows:

لَبَّكَ اللَّهُمَّ لَبَّكَ لَبَّكَ لَا شَرِيكَ لَكَ لَبَّكَ
إِنَّ الْحَمْدَ وَالنِّعْمَةَ لَكَ وَالْمُلْكَ لَا شَرِيكَ لَكَ لَبَّكَ

"Labbek Allahumma Labbek, Labbek Laa Sharika Laka Labbek, Innal Hamda Wanne'mata Laka Wal Mulk, Laa Sharika Laka Labbek".

5.5.2.4. Stay in Arafat on 9th Dul Al-Hijja

A valley named Arafat is situated about 14 Kilometers from Mecca. All Hujjaj must proceed to Arafat either in the afternoon of the 8th of Dul Al-Hijja or the morning of 9th. You must reach Arafat before the Zuhr time. At Zuhr, in Arafat, make the following Niyat for the stay in Arafat.

- I stay in Arafat from Zuhr to sunset for Hajj-Tamatto for Hajjat-ul-Islam Wajib Qurbatan Elallah”

It is Wajib to make Niyat and stay in Arafat from Zuhr to sunset. Although, not Wajib, it is recommended (Mustahib) to spend, as much time as possible, praying Salat during your stay in Arafat. The 9th Dul Al-Hijja is the day of Martydom of Hazrat-e-Muslim bin Aqeel A.S. so either attend or arrange a Majlis to commemorate that historical event. After spending the day of the 9th of Dul Al-Hijja in Arafat leave, after sunset, to go to Muzdalifa’a and perform Maghrib and Eisha’a prayers in Muzdalifa’a.

5.5.2.5. Stay in Muzdalifa’a on the 10th of Dul Al-Hijja

Although, the stay in Muzdalifa’a is Wajib from sunset to Fajr on the eve of the 10th of Dul Al-Hijja, if you reach there in the night of the 10th (after sunset of the 9th Dul Al-Hijja) then as a precaution make the following Niyat:

- I stay tonight in Muzdalifa’a for Hajj-e-Tamatto for Hajjat-ul-Islam Qurbatan Elallah.

Collect about 70 stones, per person, from Muzdalifa’a. The stones must be solid small pebbles about 1 to 1.5 inches in diameters. You will use 49 of these stones to hit (Rami) the three Shaita’ans in Mina. The extra stones are in case you miss your aim and a stone does not hit the Shaita’an. At the time of Fajr prayer make another Niyat, as follows, for the Wajib stay in Muzdalifa’a.

- I stay in Muzdalifa’a from Subah-e-Sadik to sunrise for Hajj-e-Tamatto for Hajj-ul-Islam Wajib Qurbatan Elallah.

5.5.2.6. Rami the Big Shaita’an, Al-Aqaba, on 10th of Dul Al-Hijja between Sunrise and Sunset

On the 10th of Dul Al-Hijja, immediately after sunrise, you must move to Mina from Muzdalifa’a. Mina is a field or valley located just outside of Mecca. After getting to Mina you must go and Rami (hit) the big Shaita’an, Al-Aqaba, with seven stones between sunrise and sunset. This is known as Rami Al-Jamarat Al-Aqaba.

There are two conditions for the stones:

- Stones should have been picked up from within limits of the Holy Haram, ie.; Mecca, Mina, and Mashar-ul-Hara’am (Muzdalifa’a). Arafat is not included in the Holy Haram. It is Mustahib to pickup stones from Muzdalifa’a. Also it is recommended (Mustahib) to select only those stones which are the size of one’s finger tips or upper half of thumb. In case a of shortage of stones in Muzdalifa’a you may pickup the stones from Mina. As per Ayatullah Khoei and Ayatullah Sistani, as an Ahteyat-e-Wajib, Rami (hit) should not be done from the upper level. Whereas, Ayatullah Khomeni and Ayatullah Khamenai allow Rami (hit) from either the upper or the lower levels.
- Make sure the stones you pick from the Holy Haram have not been used before. That means the stones from near the Shaita’an, which have been thrown by other people, are not allowed to be used.

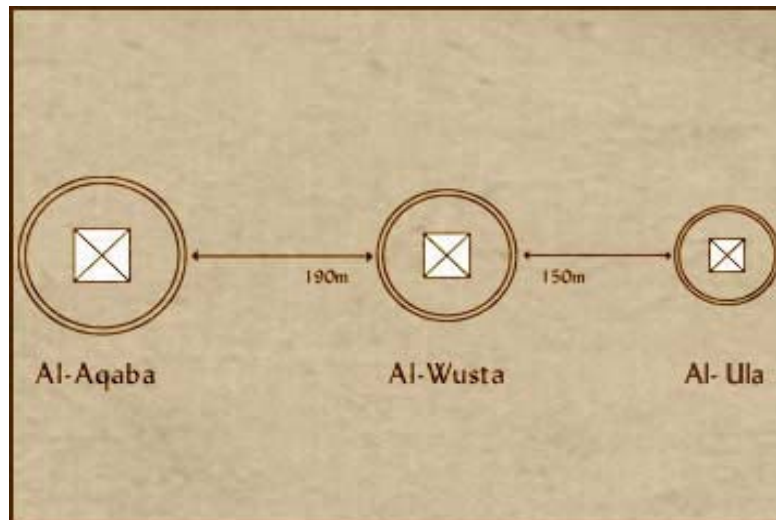
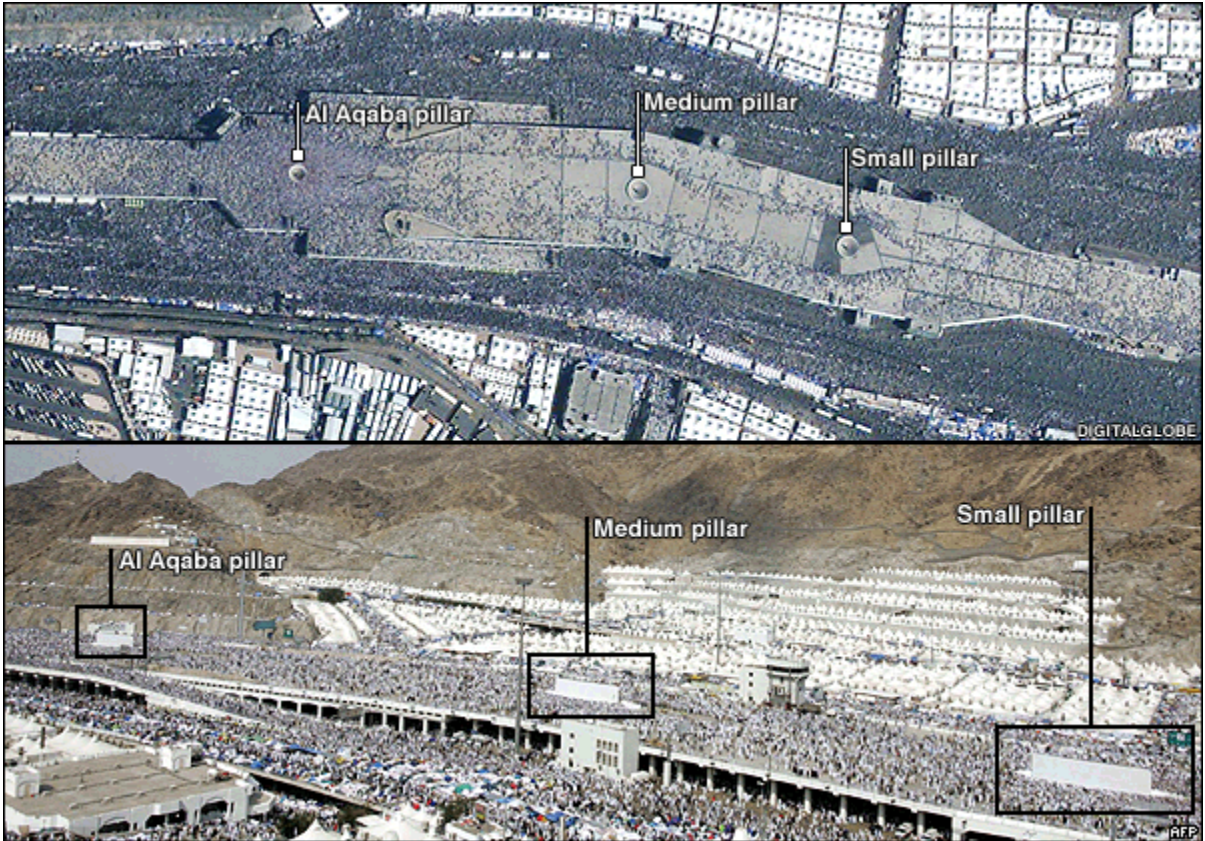

Map of the three Siateen in Mina

To Rami the big Shaita'an you must fulfill six conditions as follows:

1. Make the following Niyat.
 - I Rami (hit) the Big Shaita'an seven stones on the 10th of Dul Al-Hijja for Hajj-e-Tamatto for Hajjat-ul-Islam Wajib Qurbatan Elallah.
2. Hit at least seven stones. Less than seven is not allowed.
3. All seven stones must be thrown one after another without a time gap.

4. All seven stones must hit the big Shaita'an. In case you miss any stone, ignore that throw and use another stone to hit the big Shaita'an. You may have to throw several stones to achieve the required seven hits.
5. After you hit the big Shaita'an you are not allowed to leave the remaining stones there.
6. You must complete the Rami of the big Shaita'an between sunrise and sunset on 10th of Dul Al-Hijja.

It is compulsory, for both men and women, to throw and hit stones at the Shaita'an in person. It is not allowed to do Niyabat for this work. To avoid crowd at the Shaita'an the best time to throw the stones is right after 9:00am. For old people if it is not possible to Rami (hit) during the day due to crowding then they can do the Rami at night. Nevertheless, you must have a solid reason for doing the Rami at night.



5.5.2.7. Sacrificing an Animal on 10th Dul Al-Hijja after Rami at Big Shaita'an

Following points must be followed for the sacrifice:

- a. Make the following Niyat.
 - I sacrifice on the 10th of Dul Al-Hijja for Hajj-e-Tamatto for Hajjat-ul-Islam Wajib Qurbatan Elallah.
- b. Sacrifice must be done on the same 10th Dul Al-Hijja. Delay without a proper reason is not allowed.
- c. You may do Niyabat for sacrificing an animal for both men and women. As per Ayatullah Khomeni the butcher (slaughterer) must be Shia Isna Ashari. Other Mujtahids allow any Muslim.
- d. As per Ayatullah Khoei it is not necessary for the butcher (slaughterer) to make a Niyat. However, as per Ayatullah Khomeni the butcher (slaughterer) must make a Niyat before the sacrifice.
- e. As per Shariat the sacrifice should be done inside the Mina area. However, at present, the slaughter house is located just outside Mina. So people are bound to do their sacrifice outside Mina.

Note: As per Ayatullah Khomeni slaughter for sacrifice is allowed outside Mina. As per Ayatullah Khoei first one must try to do sacrifice inside Mina, however, if it is not possible then it is allowed to do the sacrifice outside Mina.
- f. You may select a sheep, goat, cow, or camel for sacrifice. The animal for sacrifice must be healthy and without any defects. The sacrifice of a blind, ill, lame, or very old animal is not permissible. It is okay if the animal's ears are pierced or split.
- g. After slaughtering the animal, as per Ayatullah Khomeni, it is Mustahib to divide the meat into three parts; one for yourself, one for your friends, and one for poor people. As per Ayatullah Khoei it is Ahteyat-e-Wajib to divide the meat into three parts.

5.5.2.8. Halq or Taqseer

After sacrifice (Qurbani) it is Wajib to do either Halq, which means shaving of the head, or Taqseer that means cutting some hair off the head or trimming the beard or moustache or cutting a nail. Women must only do Taqseer. The following points must be kept in mind to do the Halq or Taqseer.

- a. Firstly, make the following Niyat.
 - I perform Halq, or Taqseer, to remove Ihram of Hajj-e-Tamatto for Hajjat-ul-Islam Wajib Qurbatan Elallah.
- b. Secondly, as per Ayatullah Khomeni and Ayatullah Sistani if a man is performing Hajj for the first time then he must do Halq as an Ahteyat-e-Wajib. As per Ayatullah Khoei and Ayatullah Khamenai you may either do a Halq or Taqseer. Women must always do a Taqseer.
- c. As per Ayatullah Khoei if you know the person that will do your Halq may injure your head, and you will start bleeding, then you must first do the Taqseer followed by the Halq.

- d. You must do your Halq or Taqseer within the boundaries of Mina. It is not allowed to do Halq or Taqseer in the slaughtering area where you sacrifice an animal as that area is outside the limits of Mina.
- e. After the completion of Halq (or Taqseer) all previously discussed things that were Hara'am while in Ihram now become Halal except the following that still remain Hara'am.
 - I. Husband and wife relationship.
 - II. Fragrance.
 - III. Hunting.

5.5.2.9. Stay in Mina for the Night of 11th and 12th Dul Al-Hijja

- a. The following Niyat must be made to stay in Mina on the nights of 11th and 12th Dul Al-Hijja.
 - I stay in Mina for the night of 11th (or the 12th) Dul Al-Hijja for Hajj-e-Tamatto for Hajjat-ul-Islam Wajib Qurbatan Elallah.
- b. Only a half night stay is Wajib.
- c. As per Ayatullah Khomeni staying the first half (sunset to midnight) of the night in Mina is compulsory.
- d. As per Ayatullah Khoei you may either stay the first half or the second half of the night (midnight to sunrise) in Mina.
- e. You must leave Mina on the 12th of Dul Al-Hijja before Maghrib. It is also permissible to leave Mina right after Zhur.
- f. If for any reason you could not depart from Mina before Maghrib on the 12th then you must stay the night of the 13th, make a Niyat for the stay; Rami (hit) all three Shaita'ans on the next day (13th of Dul Al-Hijja); and then leave Mina any time after that.

5.5.2.10. Rami all Three Shaita'an on 11th and 12th of Dul Al-Hijja

You must Rami (hit) all three Shaita'ans, al-Jamarat Al-Oula (First column), Al-Jamarat Al-Wusta Second column), and Jamarat Al-Aqaba symbolizing Satan, on the 11th and 12th of Dul Al-Hijja. The following conditions must be fulfilled to accomplish this task

1. Must do the following Niyat before starting the Rami (stone throwing and hitting the Shaita'ans).
 - I do Rami (hit) seven stones to Jamra-e-Oula (or Jarma-e-Wusta or Jamra-e-Ukba) for Hajj-e-Tamatto for Hajjat-ul-Islam Wajib Qurbantan Elallah.
2. Must be done between sunrise and sunset.
3. Must start from the smaller Shaita'an called Jamrat Al-Oula, after that Jamraat Al-Wusta, and finally the Jamrat Al-Aqaba.
4. Hit at least seven stones. Less than seven is not allowed.
5. All seven stones must be thrown one after another without a time gap.
6. All seven stones must hit the Shaita'an. In case you miss any stone, ignore that throw and use another stone to hit the big Shaita'an. You may have to throw several stones to achieve the required seven hits.

5.5.2.11. Tawaf-e-Kaaba for Haj-e-Tamatto

After completing the sacrifice, Halq or Taqseer and Rami (hitting the big Shaita'an), on the 10th of Dul Al-Hijja, if possible, you may go to Mecca and complete the Tawaf-Hajj or Tawaf-e-Kaaba and Sa'ee. If you do decide to do the Tawaf-Hajj on the 10th of Dul Al-Hijja you must return to within the limits of Mina the same day before Maghrib for your Wajib stay in Mina.

You may enter the Holy Mosque (Masjid-ul-Hara'am) in Mecca from any door. However, it is preferred to enter from Bab-us-Salam (gate of peace). Immediately after entering the Holy Mosque (Masjid-ul-Hara'am) pray two Raka'at (prayer) salat with the niyat of Tahiaat-e-Masjid (as a mark of respect for the Mosque). It is mustahab to pray the two Raka'at prayer. Please find a suitable place to pray so you are not obstructing the general flow of traffic.

Making seven rounds around the Holy Kaaba (beit Allah) including the wall of Hateem (also called Hajr-e-Ismail) is termed as one Tawaf-e-Kaaba. Each round begins at the Hajr-e-Aswad (or the brown colored line on the floor that extends from the Hajr-e-Aswad towards the mount of Safa'a).

You must fulfill the following conditions before and while performing Tawaf-e-Kaaba:

5.5.2.12. Obligations to be Fulfilled before Tawaf

Before starting the Tawaf make sure you have fulfilled the following five conditions:

1. Men must have had circumcision done.
2. Your body and clothes or Ihram must be Pa'ak.
3. You must be in Wazoo and/or Ghusl.
4. For men the private parts must be covered. For women the whole body must be covered except the face and palms.
5. You must do the following Niyat before starting the Tawaf-e-Hajj.

- I do Tawaf-Kaaba of Hajj-e-Tamatto for Hajjat-ul-Islam Wajib Qurbantan Elallah.

5.5.2.13. Obligations to be Fulfilled during Tawaf

There are eight conditions to be fulfilled during the Tawaf:

1. You must make seven rounds around the Kaaba including the curved wall of Hateem (also called Hajr-e-Ismail) to complete one Tawaf-e-Kaaba.
2. No time gap is allowed between each of the rounds. No resting during the Tawaf is allowed. You may walk slowly and steadily around the Kaaba seven times to complete the Tawaf.
3. All seven rounds must begin at the Hajr-e-Aswad (black stone in the wall of Kaaba).
4. All seven rounds must end at Hajr-e-Aswad.
5. Your left shoulder must always and all the time be pointed towards the Kaaba. The Kaaba should always be on your left side and you must walk in a circle (orbit) around the Kaaba including the wall of Hateem (also called Hajr-e-Ismail). You may move your face left and right; however, keep your left shoulder always pointing towards the Kaaba. If for some reason you can not keep your left shoulder pointing towards the Kaaba then you must come back and re-do the same round from the place your left shoulder went out of direction to the Kaaba. To do that you may walk backwards, if possible, without obstructing the general flow of traffic and start your same round from the point your left shoulder went out of direction. If you can not walk back then continue forward with rest of the people around the Kaaba including the wall of Hateem and begin the same round again

from the point where your left shoulder went out of the direction to the Kaaba and so complete that round.

6. All seven rounds of a Tawaf must include the wall of Hateem (also called Hajr-e-Ismail) and must be from outside that wall without touching it.
7. Tawaf should be from outside the Kaaba. You must not enter or touch the Kaaba while doing the Tawaf. Infact you should stay about two feet away from the stone wall of the Kaaba.
8. All seven rounds of a Tawaf must be completed within the area between the wall of the Kaaba and the Maqam-e-Ibrahim (containing the imprinted feet of Hazrat-e-Ibrahim (a)). Approximate distance between Kaaba and Maqam-e-Ibrahim is 13 Meters. The distance between the Kaaba and the outside wall of Hateem (Hajr-e-Ismail) is about 10 Meters. As per Ayatullah Khumeni Tawaf should be done within a 13 Meters area of the wall of the Kaaba and within 3 Meters from the wall of Hateem (Hajr-e-Ismail) unless it is difficult to do the Tawaf due to crowding. As per Ayatullah Khoei and other Maraji, Tawaf may be performed from outside the described area, i.e.; 13 Meters and 3 Meters.

Note: If your Wazoo or Ghusl is discontinued during the Tawaf, and you have already completed 3 and a half rounds or more, then go out to make a fresh Wazoo and continue the Tawaf from the point you went out of Wazoo and complete the Tawaf by doing the remaining rounds. If your Wazoo is discontinued before completing 3 and a half rounds i.e. half Tawaf then make a fresh Wazoo and re-start the Tawaf from the beginning and perform all seven rounds to complete the Tawaf.

5.5.2.14. Salat-e-Tawaf

Pray two Raka'at Salat after Tawaf behind Maqam-e-Ibrahim. It is Wajib to pray two Raka'at Salat-e-Tawaf behind Maqam-e-Ibrahim facing the Kaaba. When praying make sure the Kaaba and Maqam-e-Ibrahim is in front of you and you can see both when you look towards the Kaaba. The two Raka'at prayer is like the Fajr prayer except for the Niyat which is as follows:

- I pray 2 Raka'at Salat of Tawaf-e-Hajj for Hajj-e-Tamatto for Hajjat-ul-Islam Wajib Qurbatan Elallah.

Note: As per Ayatullah Kheoi and Ayatullah Sistani Sajdah is not allowed on the carpet. Sajdah on a marble floor is okay and permissible.

5.5.2.15. Sa'ee

Completing seven rounds between mount Safa'a and mount Marwa'a, begining at mount Safa'a is called Sa'ee. You must perform the following Niyat before starting the Sa'ee:

- I perform Sa'ee making seven rounds between Safa'a and Marwa'a of Hajj-e-Tamatto for Hajjat-ul-Islam Wajib Qurbatan Elallah.

Start the Sa'ee from mount Safa'a and walk to mount Marwa'a once. This completes one round. Running between the green lights is Mustahib in all seven rounds of a Sa'ee. Returning from mount Marwa'a to mount Safa'a completes the second round. Complete all seven rounds such that the ending point of Sa'ee is at the mount of Marwa'a. Resting, standing, or sitting in between or at the mounts of Safa'a and Marwa'a is allowed. You may continue and complete the Sa'ee if your Wazoo or Ghusl discontinues during the Sa'ee. You must begin the Sa'ee with a Wazoo; however, it is not required to have the Wazoo until the end. So if your Wazoo discontinues during the Sa'ee it is okay to just complete the rounds.

5.5.2.16. Tawaf-un-Nisa.

For people who are married, or want to get married, one of the most important acts to be completed after the Tawaf-e-Hajj, Salat-e-Tawaf and Sa'ee is Tawaf-un-Nisa. The conditions for this Tawaf are identical to Tawaf-e-Hajj with the following two exceptions.

1. The Niyat must be done as follows.
 - I do Tawaf-un-Nisa of Hajj-e-Tamatto for Hajjat-ul-Islam Wajib Qurbantan Elallah.
2. After the Tawaf-un-Nisa Sa'ee is not required.

If you are doing Nayabat for someone else then as per Ayatullah Khoei only one Tawaf for the Marhoum (deceased) is enough. You do not have to repeat the same for yourself after completing the Tawaf-un-Nisa for the Marhoum. However, as per Ayatullah Ruhani, you must also do a second Tawaf-un-Nisa for yourself as an Ahtiyat-e-Wajib.

5.5.2.17. Salat-e-Tawaf-un-Nisa

Pray two Raka'at Salat after Tawaf behind Maqam-e-Ibrahim. It is Wajib to pray two Raka'at Salat-e-Tawaf behind Maqam-e-Ibrahim facing the Kaaba. When praying make sure the Kaaba and Maqam-e-Ibrahim are in front of you and you can see both when you look towards the Kaaba. The two Raka'at prayer is like the Fajr prayer except for the Niyat which is as follows:

- I pray 2 Raka'at Salat of Tawaf-un-Nisa for Hajj-e-Tamatto for Hajjat-ul-Islam Wajib Qurbatan Elallah.

If you are staying in Mecca, for some time, after Hajj-e-Tamatto the best thing to do is to recite and finish Quran-e-Majjeed and do as many Tawafs as possible.

5.5.3. Umra-e-Mufradah (Optional Umra)

After completing Hajj-e-Tamatto if you want to perform Umra-e-Mufradah (optional Umra, not part of Hajj) you have to go to Masjid-e-Meeqa'at (also called Masjid-e-Aisha). Where you will wear Ihram; make Niyat; perform two Raka'at Salat; and proceed for Umra-e-Mufradah. Umra-e-Mufradah consists of Tawaaf of the Kaaba; Salaat-e-Tawaaf; Sa'ee; Taqseer; Tawaafun-Nisa and Salaat-e-Tawaaf.

You can perform only one Umra-e-Mufradah for yourself and can not repeat the same till after 10 to 30 days depending on the ruling of your Marja-e-Taqlaed. However, you can perform as many Umra-e-Mufradah as you can for other people without any time limitation.

Please see table 1 in section 5.5.1.11 for the similarities and differences between Umra-e-Mufradah, Umra-e-Tamattu and Hajj-e-Tamattu. Please refer to the Islamic rulings of your Marjah-e-Taqlaed for more details on Umra-e-Mufradah.

Chapter 6. Brief Philosophy and Background of Hajj

Special Note: Many of the ideas regarding the philosophical background of Hajj in this brief section are inspired from the following book. We are very much thankful to the scholars, authors, translators and other people who helped in shaping and supporting the effort involved in producing such a remarkable and outstanding works of art, Jazak-Allah Khair!

Secrets of the Hajj by Ayatullah al Hajj ash Shaykh Husain Mazaheri, translated by Saleem Bhimji.

One of the obligatory acts of Islam is Hajj. Every able Muslim must perform it, at least, once in his or her lifetime upon fulfillment of certain conditions. The wisdom from the Prophet of Islam Hazrat Muhammad Mustafa (sal-Allah-ellahe-wa-aalle-he-wasalam) and his twelve pure Successors (ellahay-salwat-o-wasalam) unfold the philosophical and mystical aspects behind various acts performed in Hajj.

That wisdom is, vividly, recorded in many of the books of the traditions (Ahadiths). A beautiful example of one such wisdom is explained in a tradition (Hadith) attributed to the sixth Imam, Ja'far ibn-e-Muhammad Al-Sadiq (ellahay-salwat-o-wasalam). This tradition is recorded in the book called "Lantern of the Path". The text of the tradition, as translated by Fadlullah Haeri, is as follows.

"If you intend to go on pilgrimage, before resolving on it devote your heart to Allah, stripping it of every preoccupation and every barrier between you and Allah. Entrust all your affairs to your Creator and rely on Him in all your actions and moments of stillness. Surrender to His decree, decision and judgement. Abandon this world, repose, and all creation. Perform those duties which you are bound to fulfil for other people.

Do not rely on your provisions, the animal you will ride, your companions, your food, your youth nor your wealth, for fear that they will become your enemies and be harmful to you; in this way you will realize that there is no power, no strength, no might except by the guardianship of Allah and His granting of success.

Prepare for the pilgrimage as someone who does not hope to return. Keep good company, and be diligent in observing all your obligations to Allah and the Holy Prophet. Take care to show courtesy, endurance, patience, thankfulness, compassion, and generosity - always putting others before yourself - even those who reject you. Then perform an ablution with the water of sincere repentance for wrong actions; and put on the robe of truthfulness, purity, humility and fear. By donning the garments of pilgrimage, withhold yourself from everything which hinders you from remembering Allah, or that may impede you from showing obedience to Him.

Fulfill His call with an answer whose meaning is clear, pure and sincere when you call on Him, holding on firmly to your belief in Him. Circumambulate with your heart along with the angels who circumambulate the Throne, just as you circumambulate with the Muslims who go around the Ka'bah. Hasten as you run in flight from your passion, freeing yourself of all your personal assumptions of strength and power. Leave your heedlessness and errors behind when you go out to Mina; do not desire what is unlawful for you and what you do not deserve.

Confess your errors at Arafat - set out your contract with Allah by His Oneness, draw near to Him and fear Him at Muzdalifah. Climb with your soul to the highest assembly when you climb the mountain of Arafat. Slit the throat of passion and greed in the sacrifice. Stone your appetites, baseness, vileness, and blameworthy actions when you stone the Pillar of Aqabah. Shave off your outward and inward faults when you shave your hair. Enter into the security of Allah, His protection, His veil,

His shelter and His watchfulness and abandon the pursuit of your desires by entering the Sacred Precinct. Visit the House, and walk around it to glorify the Master, His wisdom, His majesty and His power.

Embrace the Stone, being content with His decree and humble before His might. Leave everything that is other-than-Him in the valedictory circumambulating. Purify your soul and your innermost being for the meeting with Allah , on the day when you will meet Him when standing on al Safa'. Take on valour and courtesy from Allah by annihilating your attributes at al-Marwah. Be consistent in the conditions of your pilgrimage and fulfil the contract you have made with your Lord, by which you will have obliged yourself to Him on the Day of Judgement.

Know that Allah made the pilgrimage obligatory, and singled it out from all the acts of worship in respect of Himself when He said:

وَلِلّٰهِ عَلَى النَّاسِ حِجُّ الْبَيْتِ مَنِ اسْتَطَاعَ اِلَيْهِ سَبِيْلًا...

"Pilgrimage to the House is incumbent upon men for the sake of Allah, and [upon] everyone who is able to undertake the journey to it... "(3:97)

The Holy Prophet ('s) established the organization of the rituals of pilgrimage, as preparation for and an indication of death, the grave, the resurrection and the Day of Judgement. In this lesson for mankind he discriminates between those who will enter the Garden and those who will enter the Fire, through his demonstrating the pilgrimage rites from beginning to end, to those with intelligence and prudence."

As per one of the tradition attributed to the Prophet of Islam Hazrat Muhammad Mustafa (sal-Allah-ellahe-wa-aalle-he-wasalam) the entire journey of Hajj is a spiritual excursion that covers three major stages as explained below.

The First Stage: *Cutting oft affinity from all things with the exception of Allah in order to reach to Allah. (سير من الخلق إلى الحق)؛*

The Second Stage: *Continuing towards Allah and strengthening the alliance (with Him), until one reaches to Allah and (the true) essence of worship. (سير من الحق في الحق).*

The Third Stage: *Once a person has reached to the level of perfection and has arrived at the stage of (true) worship, he then returns (to the people) to guide the creations of Allah towards Him (إلى الخلق سير من الحق).*

6.1. The First Stage

Two of the most important duties in the first stage of the Hajj journey are **Repentance** and **Vigilance**.

The repentance is to shun all devils and all forms of despotism, and turn back towards Allah (Subhannaha-hu-Wa-Ta'ala). It means to disregard one's material wishes and low desires emanating from the lower soul (al-Nafs al-Ammarah) and proceed towards the higher qualities of a human being and towards spirituality.

In this state the person leaves his or her home town in such a fashion that no one, except the devil (Shaitan), is upset with him. Where the person attends to and completes all of the

responsibilities and obligations from Allah (SWT) and His creations, such that no obligation is left on the person's shoulders from either Allah (SWT) or any of His creations.

The meaning of vigilance, or being vigilant, is to focus all of your attention to the grandeur and majesty of the house of Allah (SWT). Continually and consistently a person's attention is focused on the fact that it is the Creator, Maintainer, and Sustainer of the Universe that gave him the opportunity to perform His Hajj. All the time his attention is focused on not letting anyone or anything aggravate his feeling and actions. By being in, and living in such a state his Hajj maybe accepted. If his Hajj is accepted, then he has achieved the objective of his or her creation which is nearness to Allah (SWT) and reaching the true level of the worship of Allah (SWT).

The person's attention is always focused on the importance of performing all of the obligatory (Wajib) and recommended (Mustahib) acts, such as Sala'at, recitation of Qura'an-e-Majeed, humbleness, serving the creations of Allah (SWT), etc.

In such a state a women safeguards her modesty and her Islamic attire (Hijab). Both men and women focus on the importance of refraining from all sorts of sins. They are fully aware of the fact that Allah (SWT) does not accept Hajj from those who commit sins.

The person is always mindful of the fact that he or she is continually in the presence of Allah (SWT). Hence, the use of forbidden (Hara'am) wealth or property must be avoided at all cost as it leads to accumulation of sins, transgression and misfortune in this world and the hereafter.

6.2. The Second Stage

6.2.1. First Action:

The **first action** in this stage starts with the wearing of Ihram at a Meqaat (a Masjid/place which is the entry point before Mecca). The wearing of Ihram is analogous to Takbiratul Ihram, of the daily prayer, where one leaves behind all worldly thoughts and focuses one's entire attention to Allah (SWT). As in the case of Sala'at where beginning till end nothing must distract a person's attention, likewise, from wearing of the Ihram till completion of the Hajj nothing must distract a person from Allah (SWT). The person in an Ihram must fulfill the commandments of Allah (SWT).

The donning of Ihram is like putting on one's Kaffan (white shroud used for burials) where after one enters into a state that completely severs any and all links to this world. The person thus will rise in the same attire on the Day of Judgment before Allah (SWT). The Ghusal (shower to clean yourself) before putting on the Ihram is analogous to the Ghusal-e-Mayyit (washing of a body before the burial). The difference being that, in case of Ghusal before Ihram, a person in full control of his or her mental and physical capacities intentionally puts on the Ihram. Whereas, the dead body has no such worldly capacities to do Ghusal-e-Mayyit, so it is performed by others.

The Talbiyyah (phrase of reply and devotion) is recited continuously in a reply to Allah's (SWT) call after wearing the Ihram and making the intention. While reciting the Talbiyyah one should always be mindful of the fact that it is being said in the presence of and in reply to Allah's (SWT) call. While wavering between the state of fear and hope, and with an inner excitement, one cries out: "Labbaik (here I am)..."

According to narrations the Ahl al-Bait (Alehe Salwat Wa Salam) used to recite the Talbiyyah in a state where their whole body used to tremble with inner turbulence and the color of their face and skin used to turn pale. In such a state it was quite hard for them to recite the phrases of Talbiyyah. In fact, at times, they used to fall in a state of awe and total silence

during the recitation. When inquired about such a state, by the followers, Ahl al-Bait (a) replied "a Momin person, all the time, is afraid, mindful and weary of the following reply from Allah (SWT):

لَا لَبَّيْكَ وَلَا سَعْدَيْكَ

"You are not accepted and you are not welcome."

6.2.2. Second Action:

The **second action** in this stage is the Tawaf of Kaabah (making of seven circuits around the Kaabah). The Tawaf resembles the continuous act of Angels circumambulating the Throne of Allah (SWT).

Just as the Tawaf of Angels around the blessed Throne of Allah (SWT) is a sign of their love and devotion for Him, likewise the Tawaf of servants of Allah (SWT) around the House of Allah (SWT) is a sign of their love for Him.

By performing Tawaf, one is in fact proclaiming that one's self, wealth, wife, children and whatever else the person has in this world are all sacrificed for Allah (SWT) and that he is ready to give everything he has in the way of Allah and only for His pleasure.

﴿وَمِنَ النَّاسِ مَنْ يَشْتَرِي نَفْسَهُ ابْتِغَاءَ مَرْضَاةِ اللَّهِ﴾

"And from the people is he who sells his soul seeking the pleasure of Allah (SWT)."

By performing the Tawaf and arriving to the state of complete submission and servitude the veils between the servant and Allah (SWT) melt away.

The veils of self-conceit and selfishness, pride and anger, lust and greed, jealousy and miserliness are removed; and in their place are embellished the covering of humbleness and indigence in the presence of The Truth; humility and forbearance in the presence of The Creator; and asceticism, generosity and contentment in the presence of the world (the level of emptiness and annihilation).

Only in this state, will the light (*Nur*) of Allah enter into the hearts (the level of glorification) and the person will experience the path towards peace and tranquility - one after the other.

Willingly or unwillingly, one will reach to the level of closeness with Allah and of complete annihilation in Him - it is at this point that one has reached to the Straight Path (*Sirat al-Mustaqim*).

6.2.3. Third Action:

The **third action** in this stage is the Sala'at of Tawaf. The person who has just performed the Tawaf - a performance that has raised one to the level of complete servitude, must perform a prayer of thanks.

Since one has reached to the level of slavery, the ascension (*me'raj*) has become obligatory on him, and the ascension of a believer is the Sala'at.

The Sala'at is comparable to a conversation between the servant and Allah (SWT). The recitation of *Surah al-Fatiha* and other Surahs are in actuality, a mode of speaking with Allah (SWT) through His words to Him (The Creator). All that which is recited in Sala'at including the various remembrances (*adhkar*) and glorification (*tasbihat*) is actually the servant speaking to Allah (SWT).

Since Tawassul and asking for help from Ahl al-Bait (a) in every one of our actions is necessary, when the *tashahhud* and *salam* are recited, it is actually a discussion going on between the servant and Ahl al-Bait (a). This is actually a form of *Tawassul* between the servant and Allah (SWT).

6.2.4. Fourth Action:

The **fourth action** is *Sa'ee* between the mounds of *al-Safa* and *al-Marwah*. The *Sa'ee* between these two mounds is a re-creation of the beautiful historical event which was performed by one of the best creations of Allah (SWT) after Ahl al-Bait (a). Allah (SWT) the Maintainer of the universe mentioned and acknowledged that sincere act of that servant in Qur'an:

﴿وَاتَّخَذَ اللَّهُ إِبْرَاهِيمَ خَلِيلًا﴾

"And Allah took Ibrahim as a friend."

It was truly a beautiful event in which man submitted his complete entity to the Maintainer of the Universe.

It was a magnificent event in which a man - only for the pleasure of Allah (SWT) - constructed the House of Allah (SWT) a place where people would come, live and worship Him. He then left his only son, along with his wife, with these words of Allah (SWT):

'For you Allah and with hope in You, I am departing and leaving my wife and my child in a deserted area without water, food or any guardian'.

The *Sa'ee* between the two mounds of *al-Safa'* and *al-Marwah* bring to mind the beautiful event in which a woman all alone - without water, food or protection, was left in the valley and went on a desperate search to secure water for her only child. In a state of inner confusion, she ran from *al-Safa* to *al-Marwah* and then from *al-Marwah* back to *al-Safa*.

In other words, from truthfulness and honesty to compassion, humanity and courage; and from courage towards truthfulness she ran back and forth. Finally, through her sincerity, from a physical point of view - she found the water of *Zamzam*; and from a spiritual point - she found the spring of life. Through her patience and forbearance, struggle and steadfastness, she was able to make the House of Allah (SWT) an inhabited place and raise the esteem and respect of her offspring.

Between the mounds of *al-Safa* and *al-Marwah*, we must take the lesson from the self-sacrifice and total dedication of Prophet Ibrahim (a) and his companions - leaving away all things for Allah (SWT) and sacrificing our lives and properties for Allah.

6.2.5. Fifth Action:

The fifth act is *taqsir*. The *taqsir* is focusing of attention from the spiritual realm to the earthly world; looking from spiritual pleasures towards physical pleasures; looking from oneness to the multitude, which is the characteristic of Islam.

While mankind must be in constant thought and remembrance of Allah and the Day of Judgment, at the same time, it must also be in remembrance of this world and its needs.

In the narrations, from Ahl al-Bait (a), it is mentioned that one who sacrifices the next world for this world, or one who sacrifices this world for the next world is not a true Shi'a (follower of Ahl alBait (a)).

6.2.6. Sixth Action:

Traveling to, and staying for a fixed period in 'Arafat is the next action of the Hajj.

Once one has seen and been mindful of one's soul and desires (with the completion of Umra-e-Tamatto), one turns one's attention towards Allah (SWT) by wearing the Ihram a second time for Hajj-e-Tamatto. It is worn at a place where the entire spiritual realm has turned towards with complete affinity, the Kabbah. Then the servant travels is towards Arafah, for the Marifah of Allah (SWT), with an attraction that is between a sincere and pure lover and the Beloved.

'Arafah means to gain a deep understanding (*Ma`rifah*). A cognition of the beginning (of creation) and the end of all creation; a cognition of Prophethood (*Nubuwah*) and Mastership (*Wilayah*); cognition of the vista of the horizons and of the souls; cognition of all of these things and their relation with Allah (relation of an event (*Hadith*) with the Eternal Being (*Qadim*)); cognition of the guardianship of the Truth, and the absolute destitution of the creation.

'Arafat is that place where one is able to focus all of one's concentration on supplication, invocation and Tawassul - especially to *Wali al-Asr* (a) where one is in the presence of our 12th Imam (a). It is that place where one is able to reach the highest pinnacles of certainty (from *Iim al-Yaqin* to 'Ain al-Yaqin and from 'Ain al-Yaqin to *Haqq al-Yaqin*).

A person who travels to 'Arafat but is not successful in reaching the level of *Ma`rifah*, that is mentioned, even a tiny amount, in reality, has not been to 'Arafat.

6.2.7. Seventh Action:

The seventh act is to proceed to Muzdalfa'a (also called Mashar-ul-Hara'am). The land of Muzdalfa'a holds a special place with Allah (SWT) the Almighty, such that in Qur'an it has been given the attribute of being a sanctuary and a place that demands respect:

﴿ فَإِذَا أَفْضْتُمْ مِنْ عَرَفَاتٍ فَاذْكُرُوا اللَّهَ عِنْدَ الْمَشْعَرِ الْحَرَامِ ﴾

"So when you hasten on from Arafat, then remember Allah (SWT) near the al Mash`ar al-Hara'am."

One is present in Muzdalfa'a, between Fajr and sunrise, the best time during a 24 hour period in the sight of Allah (SWT), and if that which Allah (SWT) has ordained in the Qur'an is performed - which is remembrance of Allah (SWT) at that Holy place and at that Holy time - then by that remembrance, one will attain intelligence, sagacity, reason and insight.

Faith will be transmitted from one's heart to all parts of one's body. The land of Muzdalfa'a speaks to us saying, "That which you attained while in 'Arafat must be transported to your heart by the remembrance of Allah (SWT); and from the heart, it must be transported to your eyes, ears, tongue and all other parts of the body until your complete presence is given another life."

What the soul had achieved in 'Arafat must be seized and controlled. It is here that the World of the Unseen (*Alam al-Ghaib*) becomes the World of the Witnessed (*Alam al-Shuhud*).

That which was hidden, now becomes apparent; that which others can not hear, is heard; that which others can not do, one is able to perform and that which others can not see, one is able to visualize. With the eyes of heart, one will be able to see the might and power of Allah (SWT) the almighty, the *Nubuwwat* and the *Wilayat* in its true essence. In addition to this, one will also be able to see the Day of Judgement.

6.2.8. Eighth Action:

The eighth act in *Hajj* is to proceed towards Mina. Mina meaning 'returning' - what a beautiful name! It is said that an aura of light (*nur*) surrounds this area - what a place! A spiritual person's entire existence is surrounded by the light of Allah (SWT).

Mina is the place of hope and aspiration, mercy and forgiveness, nobility and grace. It is the place where one's plea and supplications are answered, and the place where good of this world and that of the next are granted, and why should it not be so? What does a lover want from the Beloved, after attaining that proximity to Him? Attention, benevolence, benignity, continuation...

After the servant of Allah has passed through 'Arafat, Muzdalifa'a and has reached the stage of proximity to Allah (SWT), what more would the servant want from his Master (*Mawla*)? Nobility, mercy, forgiveness, pardon, benignity, continuation of success till death, and to be permitted into the presence of Allah (SWT) in the hereafter. For the true lover of Allah (SWT), there can be nothing more sensual and pleasing than that.

Thus, it is said that the most sensual feeling in Hajj, is the feeling of hope of the servant of Allah (SWT) towards Allah (SWT). It is because of all the acts of devotion performed during Hajj. The time spent in Mina is the most pleasing and satisfying. The longing and desire on the part of servant towards Allah (SWT) is the foremost form of worship (*Ibadah*) and the highest position one can reach.

6.2.9. Ninth Action:

The ninth act in Hajj is to stone the *Jamarah* (*Shaita'an*). The servant who has reached the stage of closeness to Allah (SWT), has arrived to the station of fear, and rightfully so, he must fear!

The servant has arrived at a place where he or she must always be fighting against the lowly desires (*al-Nafs al-Amarah*). A place where the servant must always be aware of falsehood, despotism, internal and external despot (*Shaitan*) from amongst the Jinn and Mankind.

It is on account of this that the last Surah of Qur'an has commanded us to seek refuge with Allah from these despots and from their evil whisperings:

بِسْمِ اللَّهِ الرَّحْمَنِ الرَّحِيمِ. قُلْ أَعُوذُ بِرَبِّ النَّاسِ. مَلِكِ النَّاسِ. إِلَهِ
النَّاسِ. مِنْ شَرِّ الْوَسْوَاسِ الْخَنَّاسِ. الَّذِي يُوَسْوِسُ فِي صُدُورِ النَّاسِ.
مِنَ الْجِنَّةِ وَالنَّاسِ ﴿١﴾

"Say: I seek refuge in the Lord of men, The King of men, The God of men, From the evil of the whisperings of the slinking (Shaitdn), Who whispers into the hearts of men, From among the jinn and the men."

From the Holy Qur'an, we clearly see that the internal despot (the *al-Nafs al-Amarah*: is the most dangerous of all enemies.

Thus, once we have entered into Mina, the very first act that we must perform is *Rami* of the *Jamarah al-Uqbah* (the third and final pillar of Shaitan) which may be a manifestation of the largest despot - the *al-Nafs al-Amarah*.

The stoning of *Jamarah al-Uqbah* represents the rejection or repudiation of *al-Nafs al-Amarah*; it represents the act of discarding one's low desires and wishes in the dirt.

If one is able to crush the *al-Nafs al-Amarah* during the stoning of the *Jamarah al-Uqbah*, then one has taken the next step in attaining closeness to Allah (SWT). Since between the servant and Allah (SWT) there is no more than the distance of one step, if one has been able to take that step and make it past one's own low desires and wishes, then what follows is the level of closeness to Allah.

During the two or three days after Eid that one is in Mina, one must stone the three *Jamarat*, meaning that one must trample upon his internal despot (*al-Nafs al-Amarah*), the external despot of the Shaitan from the Jinn (Iblis and those like him), and the Shaitan from among the Humans (the enemies of religion and humanity).

The stoning of the three *Jamarat* is in essence, the trampling upon the despots and waging war against all of them. When one focuses on them and the hatred for them, then one automatically focuses with complete attention upon one's self - and rightfully so - while stoning the *Jamarat*, one must focus entirely upon one's self.

During those two or three days, if one is not able to push away the Shaitan within oneself, then one has done nothing more than just putting one's body through hardships, and in reality, one can not say that the *Jamarat* in Mina were stoned.

6.2.10. Tenth Action:

The tenth act is *Qurbani* or sacrifice. The slaughtering of an animal was and still is a tradition among all nations of people, and an act that all religions acknowledge and accept.

In the Qur'an it has been mentioned that *Habil* (*Abel*) and *Qabil* (*Cain*; sons of Adam) had offered a sacrifice, and as *Habil* was a *Muttaqi* (a pious person), his sacrifice was accepted by Allah (SWT).

﴿ اِذْ قَرَّبَا قُرْبَانًا فَتُقُبِّلَ مِنْ أَحَدِهِمَا وَلَمْ يُتَقَبَّلْ مِنَ الْآخَرِ ﴾

"When they both offered an offering, but it was accepted from one of them and was not accepted from the other."

The secret of the *Qurbani* is that one forgets everything and sacrifices all one has in the way of the Lord; one's own life, property and children. The sacrifice is a symbol of love and commitment; it is the symbol of acceptance of the personality and the respect one has for one's Beloved:

The slaughtering of an animal, like Tawaf, symbolizes the pact between the servant and the Master (*Mawla*). It is one in which the servant and all that he possesses is from his Master.

However, more important than this is that the performance of the slaughtering in Mina enlivens that great event between Prophet Ibrahim (a) and Isma`il (a).

The command came, in the form of a dream, to sacrifice the young child in Mina. Prophet Ibrahim (a) took his young son Isma`il (a) and told him about the dream. The young boy with full devotion, asked his father to carry out what has been commanded by Allah (SWT).

Both of them, with a sense of complete enthusiasm and love, proceeded to obey the command. Just at the moment when the knife, on young Isma'il (a) throat, was about to slaughter him a call came from Allah (SWT) that Ibrahim (a) and Isma`il (a) you have both successfully completed your test.

The son's sacrifice was thus changed into an animal sacrifice whereby a lamb was slaughtered instead of Isma'il (a).

Without doubt, it was a great sacrifice in the way of Allah in which a person had gone to the extreme of almost dying for Allah (SWT).

What a sweet ending, but what a bitter way to learn! What a trial that the Beloved has mentioned as something great!

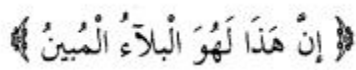

"Verily this was a manifest trial."

What was more important than this was the reward that the Beloved blessed them with and that was of being counted as true servants.

Therefore, the sacrifice of an animal is really a lesson in love; it is a lesson in devotion; a lesson for giving in the way of Allah even so much as one's own life, property and children. It is a lesson in the power of intention during tests and difficulties. It is a lesson in complete submission and true worship to Allah (SWT).

Perhaps it is because of the sacrifice that Hajj is said to be one of the best acts.

6.2.11. Eleventh Action:

The eleventh act is *Halq* (shaving off head) or the *Taqsir* (trimming of hair or nails).

Shaving one's hair on head or trimming the hair of head or beard symbolizes removal of all the sins in one's soul. It is the removal of bad traits of vanity or egotism from the heart and also a removal of worldly love for seeking a high status in the material society.

Whatever a person does to try and build one's self and ethics, one must know that the roots of the negative attributes are centered deep down in the heart of a person.

Thus, shaving the head or cutting of some hair is like removing negative attributes in a person.

Although having gone through difficulties and troubles in performing the Hajj if one has not reached the level in which one's heart is purified, one has not scored any points in the test from Allah (SWT).

An accepted Hajj is a Hajj in which after shaving or trimming the hair, one also shaves off one's heart of stubbornness, egotism, despotism, lowliness, and all the negative traits that propel a person toward sins.

Although the acts of Hajj in their apparent form are a form of worship in Islam, and denying them leads one to the state of disbelief (*Kufr*), in reality they are teachers of etiquette (*Akhlaq*) as well

6.2.12. Twelfth Action:

The twelfth act is *Tawaf an-Nisa*. After performing the *Halq* or *Taqsir*, many things which were forbidden for the person performing Hajj now become permitted - except for the use of perfume and all pleasures one derives from the opposite sex.

For these two to become permissible one must return to the House of Allah (SWT) and perform one additional Tawaf called Tawaf an-Nisa and two Raka'at Sala'at of Tawaf.

Perhaps one of the secrets behind it is that no matter what level a human reaches in witnessing the manifestation of the greatness of Allah (SWT) an even higher station and additional assistance is needed to gain authority over one's sexual instincts.

As per the Quran, in all the examinations that Yusuf (a), the Truthful, went through, he came out with passing marks, even when the group of women with their beauty, which in reality was their lack of modesty, tried to seduce him. He replied: 'O Allah! The prison is better for me than what these women say!'

However, it was the same Yusuf (a), being at the high status, when put face to face with his sexual instincts said that it was Allah who saved him, not himself, and that if He had not saved him he would have failed the exam.

Therefore, in reality there is a great lesson for all of us - especially the youth - in Tawaf an-Nisa. If we want to remain guarded from the evils of our sexual instincts, in addition to controlling them through the power of intention, we must ask for assistance from Allah (SWT) and seek His help through the religious acts of pleasure such as Tawaf an-Nisa.

6.2.13. Thirteenth Action:

The thirteenth and final act of Hajj is going to the city of *Madinatul Munawwarah* and performing visitation rites (*Ziyarat*) of the Noble Prophet Hazrat Muhammad Mustafa (a), Syeda Fatimah az-Zahra (a) and the A'immah Masumeen (a) who are buried in the graveyard known as *Jannatul Baqi*. The performance of the Hajj is incomplete without the Ziyarat of these noble personalities and can be compared to one holding firm to the Holy *Qur'an*, but not having belief in the *Wilayah*.

Bearing this in mind, we see from the ahadith of Ahl al-Bait (a) that visitation to the graves of the Prophet (p) and members of Ahl al-Bait (a) has been emphatically recommended.

Syeda Fatimah az-Zahra (a) had said: "Paradise will become incumbent upon the person who performs the Ziyarat of Rasulullah (a)."

In many other ahadith we read that the Ziyarat of Prophet Muhammad (a) is equal to the Ziyarat of Allah Himself!

In one hadith, it has been mentioned that the Noble Prophet Muhammad (a) told Amir al-Mo'minin 'Ali (a) that:

"The graves of the Ahl al-Bait are gardens from Paradise. Allah (SWT), the Maintainer of the Universe, has placed the love and yearning to visit these graves in the hearts of a select group of His servants and on the Day of Judgment, they will be at the Fountain-head of Kawthar, enjoying my special intercession. In Paradise, they will be my neighbors.

The reward of performing seventy recommended (*mustahab*) Hajj is written for such a person, and after the Ziyarat, one's sins are completely washed away like the one who is just born.

In Paradise, there is a station for these people such that no one else will be able to grasp the greatness of it. However, there are insignificant people who make fun of our visitors, and those are the worst people of my nation. They will never attain my intercession nor will they meet me at the Fountain of Kawthar!"

A few points to ponder upon for the person who has been graced with the extraordinary honor of visiting the graves of the Prophet or his Ahl al-Bait (a) are:

1. They must be aware of whose presence they are in, and know that their speech, actions, thoughts and even intentions are all presented to these holy personalities.

Thus, one must enter the sacred sanctuary with a pure heart, sincere intention and observe the proper etiquette of speaking and acting. It may be possible that reciting the salutations (*Ziyarat*) in a loud voice may not be appropriate, nor would speaking with others.

The etiquette related to sitting and standing must also be observed while in this place - just as one, during the lifetime of these holy personalities would sit (and stand). Of course - pressing one's body against the blessed enclosure (*dharrah*), kissing it and the walls of the rooms and the sanctuary is an outward show of love that each lover must perform.

2. One must prepare to enter the Sanctuary (*Holy Haram*) in order to attain the spiritual blessings, in other words, to connect oneself spiritually (with the holy personality).

How beautifully `Allamah Majlisi has said it! He relates, `I went to *Najaf al-Ashraf* and since I did not have spiritual desire to go inside the Holy Haram for a few days, I spent my nights in the sacred courtyard, and spent my days in the graveyard of *Wadi as-Salam* near the *Maqam (Station) of al-Qa'im* (a). I practiced religious self-discipline until I reached the level of attaining divine inspiration and enlightenment (and then entered the Holy Haram).'

3. Paying attention to the fact that sins, especially those which are referred to as *Haqq al-Nas* - the sins which are related to other people - cause agony to the hearts of the Ahl al-Bait (a). In many narrations we read that the A'immah Masumeen (a) had said that oppression to our Shi'a is equivalent to oppressing us.

Thus, if we want to please the Ahl al-Bait (a) we must make a firm resolve that we will never turn away from helping and aiding other Shi`a and other human beings. We must also make a firm resolve that we will not oppress or ridicule any of their friends. After making this resolution and asking forgiveness, we enter their sanctuary.

4. One's motivation must be high, and he must not limit himself to simply asking for things of this world and the next. Rather, these requests should be left to them (to decide for us).

Further, one's request and desire must be that their light (*nur*) should be graced upon us.

One must rely upon the leadership of the physical world (*Wilayah Takwini*) that they possess so that we can be elevated (in status).

The light (*Nur*) are the Ahl al-Bait (a). Without them, there is not a single creature that can ever reach to perfection, nor can they reach to the level of connection with Allah (SWT).

Any person who does not take guidance from them while engaging on the path of *sair wa suluk* (*Spiritual travel & journey towards Allah*), instead of reaching to a level of connection with Allah (SWT) will actually be cut off from Him and instead of guidance will fall into darkness and misguidance.

From the point of view of the Qur'an, those responsible for guidance towards this path are the Ahl al-Bait (a). During our present time, the axis of the world of possibility (*al-Alam al-Imkan*), the pivot of the world of creation, and the intermediary between the unseen and witnessed (*ghaib wa shuhud*) is Imam Wali al-`Asr (a).

﴿ وَجَعَلْنَاهُمْ آئِمَّةً يَهْدُونَ بِأَمْرِنَا ﴾

‘And We made them Imams who guided (people) by Our command.’

Therefore, *Tawassul* is one of the necessities, and the best form of *Tawassul* is to visit the sacred graves (*Ziyarat*) of the Ahl al-Bait (a); and further, if one is fortunate enough, to be at the service of Imam Wali al-`Asr' (a).

Imam 'Ali ibn Musa al-Rida (a) has said that every Imam has an oath or pledge that binds every Shi'a and true lover, and the best way of showing one's loyalty to this pledge or oath is to visit their graves.

Any Shi'a that performs the ziyarat of Ahl al-Bait (a) will receive their intercession on the Day of Judgment. Visiting the graves of Ahl al-Bait (a) will guide one in this world as well as in the next.

6.3. The Third Stage:

Returning to one's hometown from Mecca and Medina is the third stage.

In this stage the responsibilities are a lot more difficult than the first and second stage. At this level one's responsibilities bear similarities to that of a Prophet of Allah (SWT).

In the earlier stages one is busy in self-building. Whereas at this stage one is working to educate, enhance and build others' characters. Although the act of enlightening others depends upon self-building, it is quite a difficult task, about which the Noble Prophet Muhammad (a) said:

شَيْبَتِي سُورَةُ هُودٍ لِمَكَانِ قَوْلِهِ: ﴿ فَاسْتَقِمْ كَمَا أُمِرْتَ وَمَنْ تَابَ مَعَكَ ﴾

"Surah Hud made my beard white from the point where it was revealed, ‘Continue then in the right way as you are commanded, as also he who has turned (to Allah (SWT)) with you (O' Muhammad (a))’."

Quran commands about self-building in Sarah al-Shuara where it says:

"Continue then in the right way as you are commanded."

However, that which caused beard of the Prophet (p) to turn white was the command to build others:

﴿...وَمَنْ تَابَ مَعَكَ﴾

"...as also he who has turned towards Allah with you (O' Muhammad)."

After returning from Mecca and Madina the Hajji must actively convey what he has brought with him in terms of self-building to others. That message is conveyed through the Hajji's actions, speech, manner and disposition. His "new self" is truly a best gift that he brings back as an example for others.

The Hajji must inform others of the importance of Salat by performing it right when the time sets in, reciting it in the Masjid, in congregation (*Jama`at*), and paying attention to the overall importance of it.

The *Hajji who* is not concerned about Salat and is absorbed in making a living at the time of Salat has truly not experienced the Hajj. The Quran speaks to people like this and curses them by saying: `Curse be on you - you are not a Hajji -rather, you are not even a Muslim!'

﴿فَوَيْلٌ لِلْمُصَلِّينَ الَّذِينَ هُمْ عَنْ صَلَاتِهِمْ سَاهُونَ﴾

"So then woe to those who pray - those of them who are heedless of the Salat."

Paying attention to all Islamic acts which are obligatory (*Wajib*); namely paying *Khums*, and to those which are forbidden; such as not taking interest and bribes, not selling short of the contract, not selling things for more than their worth, not to hoard or cheat in business transactions, etc. are some of the traits that one must bring back from the Hajj as gifts.

The woman who has just returned from Mecca and Medina after the Hajj must improve her hijab, and make it the same as the hijab of Syeda Fatimah az-Zahra (a) in a way that her covering serves as an example and ideal for others to follow.

Acknowledgements

We would like to thank the authors, editors and reviewers for their contributions to the Hajj guide. We are especially grateful to Brother Hussnain Gardezi for his tireless efforts and drive that made this guide possible. We also thank Hojjatul Islam Dr. Nabi Raza Abidi for providing the motivation, invaluable guidance and editorial comments for the project.

Please remember in your prayers all the people involved in this effort.

Hajj Guide contributors:

Hojjatul Islam Dr. Nabi Raza Abidi

Hussnain Gardezi

Batool Gardezi

Urooj Kazmi

Akber Kazmi

Ali Hasan

Sayeed Himmati

Haider Ali

And the 2003 SABA Hajj group who reviewed the original draft in Mecca

We are very much thankful to the scholars, authors and translators of the numerous books which were used for the inspiration and creation of this guide.

Appendix A: Reference Hajj books for additional reading

1. **Hajj – The Islamic Pilgrimage** by Syed Mohammad Zia Abidi
On-line at: <http://www.al-islam.org/thehajj/>
2. **Secrets of the Hajj** by Ayatullah al Hajj ash Shaykh Husain Mazaheri,
translated by Saleem Bhimji.
On-line at: <http://www.al-islam.org/secretsofthehajj/>
3. **“Hajj”** by Dr. Ali Shariati
translated by Ali A. Behzadnia, M.D. and Najla Denny.
On-line at: <http://www.al-islam.org/hajj/shariati/>
4. **“Lantern of the Path”** by Fadlullah Haeri
translation of the original Arabic text titled “Misbah al-shariyah wa Miftah al-Haqiqah”.
On-line at: <http://www.rafed.net/books/other-lang/mesbah/>
5. **Manasak-e-Hajj in Brief** by Ayatollah al-'Uzma Sayyid Ali Husseini Khamene'i
On-line at: <http://www.wilayah.ir/en/library/hajj.php>
6. **Manasak-e-Hajj** by Ayatollah al-'Uzma Sayyid Ali Husaini Sistani
On-line at: <http://www.sistani.org/html/eng/menu/2/books/3/>

Appendix B: Useful English to Arabic Words and Phrases

Greetings

Good Morning	Sa-bah al-khair
Good Morning (reply)	Sa-bah al-nur
Good afternoon or evening	Mas-sa Al-khair
Good afternoon or evening (reply)	Mas-sa Al-nur
Hello	As-salam a-lay-kum (Peace upon you)
Hello (reply)	Wa a-lay-kum as-sa-lam (Upon you be peace)
Hello	Mar- ha-ba
Welcome	Ah-lan (also said in departing)
Nice to meet you	Sorirat Biro'aitak
What is your name?	Ma Ismok?
How are you?	kheif halak (m) haliki (f)
Good	Tayyib / Bikair
Bad	Saia / Mosh Bikair
So so	Eaini
Do you speak English	Tatakallum Ingleezi?
Al right (okay)	Qwai-yis
Good-bye (with peace)	Ma salaama
Please	min fadlak (m) iki (f)
Thank you	shukran
Thank you very much	Shukran Gazillan
Excuse me	Ann Eazinak
You are welcome	"afwan, ahlan wa sahlan"
Excuse me / sorry	assif
God willing	Insha`allah
Very Well	"tamam, bikhair "
Yes	Na'am/ai-wa
No	La

Personal Pronouns & Relationships

I	Ana
We	Nahnoo
You (singular)	"Anta (male), Anti (female)"
You (plural)	"Antom (m), Antona (f)"
They	"Hom (m), Hoonna (f)"
Friend	Sadik
Wife	Zaoga
Husband	Za'og
Daughter	Ibna
Son	Ibn
Mother	Um
Father	Ab

Traveling

Give me	A'ti-nee/Haat
Do you understand	Fa-him?
Straight (ahead)	A-la tool
Right	Ya-meen
Left	Ee-sar/sha-mal
U-turn (return)	Ar-ja

Stop (here)	Wa-gaf (hen-na)
Slow down	"Shwai-ya, shwai-ya "
Near	Ga-reeb
Before/in front of	Ga-dam/a-mam
Beside	Jamb
Wait (a little)	Sta-na(shwai-ya)
Go...	rouh
Street	Shar-a
Road (Medina)	Ta-reek (Ma-dee-na)
Bridge	Koo-bree
Up/on	Foke
Down/below	Taht
My name is	Is-mi
Where is...	wain
the bank	IL masrif
the restaurant	IL mataam
the telephone	IL hafif
the airport	IL matar
the post office	maktab IL bareed
the toilets	IL hamam
the hospital	IL mustashfa
the police station	dar al shurta
The road	al shar'e
Fine (reply)	Al Ham-du-li-llah (Thank God)
Food	Akl
Money	Floose
Gasoline /petrol	Ben-zeen
Gift	Ha-diy-ya
Mosque	Mas-jiid
Guard	Ha-ris
Quickly	Be-soo-ra
How are you?	Kaif-Hal-ak
Behind	Wa-ra/khulf
I don't speak Arabic	La-A-ta-ka-lam Ar-a-bi
It does not matter	Ma-lesh
Important	Mu-him
Impossible	Moshe mum-kin
Information	Ma'lu-mat
Is it possible?	Mum-kin?
Menu	Me-nu
milk	Ha-Leeb
My address is ..	Un-wa-ni...
Shop	Doo-kan/ma-hal
Departure Time	Waqt As sa-far
Driver	Saw-wak
Traffic police	IL murur
Car	Sai-ya-ra
Airplane	Tie-ya-ra
to the left	ala al yassar
to the right	ALA al yameen
Go straight on	alatool
Roundabout	al dawar

Places

Airport	Al ma-tar
Bank	Bank
Police	Shu-rta
Company	Shar-e-ka

Compound	Sa-kan
Downtown	Al ba-lad
Hospital	Mus-tash-fa
Hotel	Foon-dook
House(villa)	Beit/fil-la
International Market	Al souq al dow-lee
Market	Souq
Mini Market	Baa-ka-la
Permit	Tas-reeh
Problem	Mush-kill-a
Reservation	Hajz
Soldier/military person	As-kar-ee
"Sorry, excuse me"	Mut-a'a-ssif
Suitcase	Shan-ta
Telephone	Ta-li-fone
There isn't	La yuu-jad.../Ma fee ..
Pharmacy	Sayee-da-lia
Police Station	Ma-ha-ta al Shur-ta
Post Office	Al Ba-reed
Stationery Store	Mak-ta-ba

Other Useful Words & Phrases

Ticket	Taz-kara
Well (good)	"Tay-yib, Bi-khair "
Where is?	Ein-a/fain../wain
This is an emergency	Haa-dhi taa-ri-ah
Where is the hospital?	weyn al-mus-tash-fa
I don't speak Arabic	ma-fi Ar-ab-ie
finished / completed	khal-las
hello	mar`-ha-ba
help!	an-naj-da
hospital	al-mus-tash-fa
hotel	foon-dook
if God wills (maybe)	In-shaa'-al-lah
money	Floose
not present/don't have	ma-fi
please	min-fad-lak
police	ash-shur-ta or Shu-ria
cold	baa-rid
hot	haar or sukhon
go	im-she
good – okay	quay`-is
finished / completed	khal-las
I feel ill	ana mareed/a (f)
Water	Mo-ya
Coffee	Qah-wa
Bread	Khoo-boos
it doesn't matter	maa-leysh
Is that possible?	mum-kin
praise/thanks to God	al-ham-du lil-la
present have	fi
problem	mush`-ka-la (mushkala)

sea	al-ba-hr (al-bahr)
stop	gif
telephone	at-al-li-foon
thank-you	shuk`-ran
this	haa-dha (hada)
where?	weyn
what?	ish
water (to drink)	moya or moy
I don't understand	anna mush fahim
Why?	lain?
Who?	meen?
What is this?	shu hatha?
When?	mata?
How?	kaif?
I feel ill	ana mareed/a (f)
A little (or slowly)	shwai
Crazy	majnoon

Days

Saturday	al sabat
Sunday	al ahad
Monday	al ithnain
Tuesday	al thalatha
Wednesday	al arba
Thursday	al khamees
Friday	al juma
Today	Il-yawm
Tomorrow	Bu-kra
Yesterday	Ams/ al Ba-ri-ha
After tomorrow	baad bukra
In the morning	fe al sabah
In the afternoon	baad al dhuar
Tonight	fel al massa

Shopping

How much is this?	bikam hatha?
What is the discount?	kam il khasem?
I want to buy....	Anna ureed ishtaraiti
¼ Kilo	ruba kilo
½ Kilo	nusf kilo
One bottle	zujajah wahida
My name is...	ismee
What is your name?	ma ismiki (f)
How much?	Kum?
Please	Mini fad-lak
Thank you	Shu-kran
It is too expensive	ghalia katheer
It is too cheap	hatha rakhees jedan
Thanks be to God	al hamdulillah
Stop	giff/towagaff
Finished	intaha/khalas

Numerals

Although Arabic is written from right to left surprisingly numbers are written from left to right and in the same manner as English. Thus, 348 in English would be written 348 in Arabic, simply substituting

Zero	Sifr	Six	Set-ta
One	Wa-hid	Seven	Sa-ba
Two	Ith-nain	Eight	Tha-man-ya
Three	Tha-la-tha	Nine	Tis-a
Four	Ar-ba	Ten	Ash-ara
Five	Kham-sa		

All the numbers that are a combination of "10's" and "1's" are said "1's" and "10's". For example 23 would be said 3 and 20 in Arabic. However, the tens have their pronunciation a bit altered. Here are numbers 11 - 22 and 10's:

Eleven	Ehd-ash	Twenty one	Wa-hed wa-ash-reen
Twelve	Ith-nash	Twenty two	Ith-nain-wa-ash-reen
Thirteen	Ta-lat-ash	Thirty	Ta-la-theen
Fourteen	Aar-bat-ash	Forty	Ar-ba-reen
Fifteen	Kham-stash	Fifty	Kham-seen
Sixteen	Sit-ash	Sixty	Sit-reen
Seventeen	Sa-bat-ash	Seventy	Sab-a-reen
Eighteen	Ta-man-t-ash	Eighty	Ta-man-reen
Nineteen	Ti-sat-tash	Ninety	Tis-a-reen
Twenty	Ash-reen		

Note: The "een" suffix is one form that Arabic use for the plural.

For the hundreds, Arabic is a bit more complicated. The numbers are said "100's and 1's and 10's. for example, 365 would be said 300 and 5 and 60. Here are the hundred:

One Hundred	Mee-a	Six Thousand	Si-tat al-af
Two Hundred	Mee-a-tain	Seven Thousand	Sa-bat al-af
Three Hundred	Ta-la-ta-mee-at	Eight Thousand	Ta-man-yat al-af
Four Hundred	Ar-bat-mee-at	Nine Thousand	Ti-sat al-af
Five Hundred	Kham-sat-mee-at		

Useful English – Arabic Word and Phrases in Alphabetical Order:

and	wa	faster	besoraa
are you finished	hul khalast?	fire extinguisher	taffaya, harik
B.O.P. wrench	mufta B.O.P.	fire	narr
ball pein hammer	shakoosh saghir	fish	samak
bathroom	hamam	fork	showka
be careful	entabeh	finished	khalast
bed	sarier	food	akal
big	kabier	fork	showka
bigger	akbar	Friday	yom el gomao
black	aswad	friend	sadiq
blowout	yeseal	full	Maliin
blue	asrag	Gallon	gallon
board	khashab	garbage	zibala
bolt	borshe mosmar	give	yat 'i, ed 'i
bottom	tahat	go	roah
boy	walad or sabi	God's Will	inshaalha
break out	excer	Good	kowiees
bring me..	jiegeblye..	good bye	maasalaama
brush it	farshee or nadaf	good morning	sabah al khair
cable, rope, wire	z elk kahrabah, habp, z elk	green	akhdar
camp	camp or mokhiam	half	nos
carry	ehmel or sheif	hammer	shakoosh
cement	ismint	handle	mekbad or yed
change elevators	badel elevators	harder	akoa
change packing	badel packing	hello	marhaba salam alekom
change...	badel..	help him	saedo
check oil in engine	efhas el zait engine	help me	saadni
check...	efhas...	help them	saedhome
chemicals	chemicals kimaweyat	here	hema
chicken	dajaaj	him	howa
clean the threads	nadef el senoun	hit it	edrob
clean with water	nadef bil mayia	hold	emsiek
clean with diesel	nadel bil diesel	home	biet
clean this	nadef haza or nadef dah	hook up..	rakeb...
clean out..	nadef...	hot	sochen
close..	sacer..	how many	cam
coffee	kahwa	how much does this cost	cam thamen haza or bekam
cold	bard	how	keif or ezai
come here	taa'la hena	how are you	keif halac of ezaiyak
come with me	taa'la maei	hurry	besorao
come	tah al	I am fine	ana mabsoot, ana kowayes
cook yet	'bokh	I am happy with your work	Ana mabsout beshughlak
do you have..	indek..	I want...	ariyad or aawez
do you want coffee	ayez kahwa	I want it rare	ariydah mistawiiy shway
do not throw away	la termi	I want to eat	aryid aakol
do you understand	inta fahamt	I am going to...	ana raieh ela...
down	tahat	I am hungry	ana gowaan
driver	sawag	I, me	ana
early	badri	iced tea	shaay barid
easy	sahel	in my room	fil ghurfa
eat	yacol	in pick-up (car)	fil sayyana(sayyara)
electrician	kahrabaii	in the house	fiel beit
elevator	aceussor	inch	busa
emergency	Tawarek	inside	gowah
empty	faregh	install..	rakeb...
everything	kollo	is it clean	hal howa nadif or hal dah nadif (for things)

knife	sikkiyn	rare	mistawiiy shway
later	baedien	red	ahmar
lay down	rayeh or nam	remove..	eshab.., sheel...
leaking	yesayel	repair...	sallah el..
left	yasaar	ride	ercab
let's go	yala	right	yamien
litre	litr	roughneck	couhe khechen
little	shoeya	run run! in emergency	egry besoraa (run fast)
load this	hamal haza	sack	kies
long	tawiel	salt	malh
longer	attwal	Saturday	yown is-sabt
look out!	shoef	save	waffer
lots, many	ketier	safety	amaan
man -- men	reejal	short	osayer
manager	mudier	shorter	aasar
maybe	yem ken	shovel	shibel
meat	lahma	sleep	noum
mechanic	mekanic	slowly	shwai shwai
medium	matawasat	smaller	asghar
metre	mitr	soup	shurba
milk	haliyb	speak slowly	takallam besch wesch
mix	khalit	spoon	maalaka
Monday	yowm el itnen	sugar	sokkar
money	feluus	Sunday	yowm il-ahad
moron	gha 'bi	tea	shaay
motorman	rakeb motocykl	thank you	shukran
mud	tina	thank god	alhandullellah
my name is.....	Ana ismee...	that	hazah
never mind	maalish	that's enough	bass or kefaya
new	jadiid	them	homma
no good	mosh kowayes	there	honak
no, I don't have	laa ma audich	this	haza
no	la	this way	kidha
not that way	moush kedah	threads	asnan
nothing	wala hayoh	throw away	ermi
now	delwakty	Thursday	yown il-khamiys
nut	samola	tie on to...	erbott..
office	mactab	tip	bakchies
oil	zeit	tomorrow	boukra
oilfield	el maw keeh	top	fouk
old	atiik or kadeem	tripping	eddy bakchies
open	eftah	Tuesday	yowm ith-thalaatha
open valve	eftah el mahbas	turn loose	fok or hel
outside	barra	turn over	eclab
over there	hunak	turn	lef
paper	waraq	unload this	nasel dah or nasel hasa
pepper	filfil	up	foak
pen, pencil	kalam	Vegetables	khudra
pick this up	erfah haza foak	wait a minute	estana shoeya
please	men fadlak	waiting for orders	mestani awamer
Please, have a coffee	Etfadal echrab kahwa	walk	emshi
poison	sem	warehouse (spare parts storage)	makhzau
pull	eshab	what do you want	ayez eh ?
pull in the shoe	eshab el shoe	what is this	eh dah?
pump	tromba	what is your name	shoe ismack or ismack eh
push	zok		
put it there	hot honak		
put it..	hot..		
put this...	hot haza...		

Appendix C: Glossary of Words Used in Religious Texts

A

afdhal meritorious
ahkam decrees or injunctions; plural of hukm
ahwat greater precaution or care
'Arafat the 9th day of Dhu'l Hijjah when the pilgrims assemble at the place outside Mecca, known as the plain of 'Arafat
'asr afternoon
aqwa (what is) more stronger or forceful
ashwat rounds or turns; plural of shawt

B

badhl gift, present
Badhli Hajj Gifting of Hajj; sending someone on Hajj as a way of generosity
Bayt Allah al-Haram The Sacred House of Allah

D

dhibh slaughtering, animal sacrifice

E

Eid al-Qurban Feast of Sacrifice celebrated on 10th Dhu'l Hijjah

F

faridhah an indispensable religious duty
fuqaha jurists
fusuq disobedience to the commands of God; committing sins

G

ghayr ul-mIhram one who is not mIhram
ghusl ritual bathing

H

hadath akbar major impurity requiring ghusl
hadath asghar minor impurity requiring wudhu
hady animal sacrifice, sacrificial offering
hai'dh menstruating
Hajar al-Aswad The Black Stone
Hajj pilgrimage
Hajjat ul- Islam the obligatory Hajj pilgrimage in Islam
Hajji pilgrim
Hajj Miqati Hajj which starts from one of the mawaqit or the specified places where pilgrims are required to assemble
Hajj Nyabi pilgrimage performed on one's behalf
halal permitted; religiously lawful
halq complete shaving of the head
haram prohibited; religiously unlawful
Haram sanctuary, sacred precincts
harwalah with a fast pace
haydh menstruation

hijab Islamic mode of dressing and covering for women
Hijr Isma'il The semi circular 1.3 meter high wall on the northern side of the Ka'bah, where Ismail and his mother Hajar are buried
Hujjaj pilgrims
hukm religious decree or injunction acts of worship

I

'ibadat acts of worship
idhn permission
idhtirar exigency; urgency; emergency need
idhtirari based on exigency, exigent, emergency
ihram state of pilgrim sanctity, which a pilgrim of Hajj or Umrah assumes on reaching miqat
ihtiyat precaution, reservation
ikhtiyar choice
ikhtiyari based on choice, optional
istighfar seeking forgiveness
istihbab considering an act as mustahabb; recommendable
istita'ah capability
itmam reciting the prayer completely as opposed to the shortened prayer of the traveller

J

jidal quarrelling, swearing
janabah major ritual impurity caused by sexual intercourse or the like
jabirah wudhu a special kind of ablution for one who has bandages or the like on the parts which should be washed during wudhu
junub one who is in the state of janabah

K

kaffarah expiation, atonement
khums one fifth levy
kifayah being sufficient, sufficiency, competence, capability
kurr water weighing about 384 kilograms which does not become najis if nijasah reaches it

M

Medina Medina
ma fil-dhimmah an act or deed which is incumbent on the pilgrim and should duly be discharged
maghreb sunset
mIhram Relations with whom marriage is not permissible such as father, mother, step father, step mother's, sons, daughters, brothers, sisters, grandfathers, grandmothers, grandsons, grand daughters, maternal or paternal uncles and aunts, nieces, nephews, grand nephews and grand nieces, father law and mother law, son law and daughter law, wet nurses, etc. Consequently husband and wife are considered mIhram to each other

Mecca Mecca

mal al-ijarah wages paid to a person hired as a na'ib

Marja' Taqlid Religious Authority for following such as the Chief Jurisprudent

masjid mosque

mataf place for (conducting) the tawaf

miqat a number of stations outside Mecca from where the pilgrims intending Hajj or Umrah assume ihram

mubah. permissible; allowed

muharramat acts and things which are religiously unlawful

muhill one who has been relieved from ihram, non muhrim

muhrim a pilgrim in the state of ihram

mukallaf one who has reached the age of takleef

mustahabb desirable though not obligatory; recommended

mustahsan praiseworthy; commendable

mustati' a person possessing capability (istita'ah)

N

nadhr vow

nafelah prayer supererogatory prayer

na'ib deputy

najis ritual unclean

nifas puerperal period

nijasah ritual uncleanness

niyabah deputation

niyyah intention

Q

qadha settling a wajib act which had not been performed in time, not performed but due

qaleel little in quantity, less than kurr

qasr reciting two rak'ah instead of the 4 rak'ah prayer during a journey exceeding 23 Kms

qira'ah the recitation of the Qur'an in the prayer

R

rak'ah unit of the length of prayer

ramy threefold throwing of stones at al-jamarat or symbolic Satans

rukun essential part or pillar

S

sajdah prostration

sa'ee seven rounds between mount Safa'a and mount Marwa'a

T

taharah purity, cleanness

tahlil relief from the state of ihram

tahiyyat respect

takleef age in which one becomes mature and thus responsible for performing Islamic duties

taqsir partial shortening of the hair on the head

tashriq period the three days following Eid al-qurban

tawaf sevenfold circumambulation of the Ka'bah

tayammum statutory dry ablution with soil, sand, etc.

U

'udul change of purpose by the na'ib

Umrah (in common usage) visit, (in religious texts)

paying a visit to the Bayt Allah al Haram (the Sacred House of Allah, i.e. the Holy Kaabah)

Umrah- Mufradah Umrah performed independently of Hajj

W

Wajib span

wajib religiously obligatory

wajib Hajj obligatory pilgrimage

Wajib ul-Hajj one for whom Hajj has become obligatory

wajibat obligatory acts and deeds

wali guardian, heir

wikalah deputation

wudhu ablution with water

wujub obligation

wujud shareeyah religiously due sums, religious payments

wuquf stop, halt

wuqufayn the two stays

Z

zawal time when the sun crosses the meridian

ziyarah visit

zuhr noon